

3A Composites GmbH

Alusingenplatz 1
78224 Singen
Germany

Tel: 00 49 7731 80 3500 Fax: 00 49 7731 80 3510
e-mail: info.eu@alucobond.com
website: www.alucobond.com

Agrément Certificate
05/4214
Product Sheet 1

3A COMPOSITES CLADDING SYSTEMS

ALUCOBOND CLADDING SYSTEMS

This Agrément Certificate Product Sheet⁽¹⁾ relates to ALUCOBOND Cladding Systems, comprising aluminium sheet composite panels attached to an aluminium sub-frame, used as a drained and back-ventilated rain screen cladding system to provide a decorative and protective façade over external concrete, masonry, steel and timber frame walls of new and existing buildings. Their use is restricted in some cases.

(1) Hereinafter referred to as 'Certificate'.

CERTIFICATION INCLUDES:

- factors relating to compliance with Building Regulations where applicable
- factors relating to additional non-regulatory information where applicable
- independently verified technical specification
- assessment criteria and technical investigations
- design considerations
- installation guidance
- regular surveillance of production
- formal three-yearly review.



KEY FACTORS ASSESSED

Strength and stability — the cladding systems can resist the surface loadings normally encountered in the UK and transfer the design loads to the substrate wall structure (see section 6).

Behaviour in relation to fire — Alucobond A2, Alucobond Plus and Alucobond PE flat panels have reaction to fire classifications of A2-s1,d0, B-s1,d0 and D, respectively, to BS EN 13501-1 : 2007. Alucobond Plus and Alucobond PE are restricted, in some cases (see section 7).

Air and water penetration — provided all joints between panels are adequately baffled, the cladding systems will minimise water entering the cavity. Any water collecting in the cavity due to rain and condensation will be removed by drainage and ventilation (see section 8).

Durability — the cladding systems have acceptable durability and can be expected to have a service life of in excess of 30 years (see section 10).

The BBA has awarded this Certificate to the company named above for the systems described herein. These systems have been assessed by the BBA as being fit for their intended use provided they are installed, used and maintained as set out in this Certificate.

On behalf of the British Board of Agrément

Date of Second issue: 4 August 2017

Originally certificated on 24 March 2005

Certificate amended on 30 August 2017 for inclusion of revised NHBC statement.

Certificate amended on 2 July 2019 to include Regulation 7(2) for England and associated text.

Certificate amended on 13 January 2020 to include new regulatory guidance for fire in Scotland and Wales.

Brian Chamberlain
Brian Chamberlain
Head of Technical Excellence

Claire Curtis-Thomas
Claire Curtis-Thomas
Chief Executive

The BBA is a UKAS accredited certification body – Number 113.

The schedule of the current scope of accreditation for product certification is available in pdf format via the UKAS link on the BBA website at www.bbacerts.co.uk

Readers MUST check the validity and latest issue number of this Agrément Certificate by either referring to the BBA website or contacting the BBA directly.

Any photographs are for illustrative purposes only, do not constitute advice and should not be relied upon.

British Board of Agrément

Bucknalls Lane
Watford
Herts WD25 9BA

©2017

tel: 01923 665300
clientservices@bbacerts.co.uk
www.bbacerts.co.uk

Regulations

In the opinion of the BBA, ALUCOBOND Cladding Systems, if installed, used and maintained in accordance with this Certificate, can satisfy or contribute to satisfying the relevant requirements of the following Building Regulations (the presence of a UK map indicates that the subject is related to the Building Regulations in the region or regions of the UK depicted):



The Building Regulations 2010 (England and Wales) (as amended)

Requirement:	A1	Loading
Comment:		The systems are acceptable for use and can be designed to adequately transfer the design loads from the cladding to the substrate wall structure as set out in sections 4.3 and 6.1 to 6.11 of this Certificate.
Requirement:	B3(4)	Internal fire spread (structure)
Comment:		The panels are restricted by this Requirement. See section 7.2 of this Certificate.
Requirement:	B4(1)	External fire spread
Comment:		The panels are restricted by this Requirement in some cases. See sections 7.1, 7.3, 7.5, 7.6 and 7.9 of this Certificate.
Requirement:	C2(b)	Resistance to moisture
Comment:		The systems will satisfy this Requirement. See section 8 of this Certificate.
Regulation:	7(1)	Materials and workmanship
Comment:		The systems are acceptable. See section 10 and the <i>Installation</i> part of this Certificate.
Regulation:	7(2)	Materials and workmanship
Comment:		The panels are restricted by this Regulation in some cases. See sections 7.1, 7.3, 7.5, 7.6 and 7.9 of this Certificate.



The Building (Scotland) Regulations 2004 (as amended)

Regulation:	8(1)(2)	Fitness and durability of materials and workmanship
Comment:		The systems are acceptable. See sections 9 and 10 and the <i>Installation</i> part of this Certificate.
Regulation:	9	Building standards applicable to construction
Standard:	1.1(a)(b)	Structure
Comment:		The systems are acceptable with reference to clause 1.1.1 ⁽¹⁾⁽²⁾ . See sections 4.3 and 6.1 to 6.11 of this Certificate.
Standard:	2.4	Cavities
Comment:		The panels are restricted by this Standard, with reference to clause 2.4.2 ⁽¹⁾⁽²⁾ . See section 7.2 of this Certificate.
Standard:	2.6	Spread to neighbouring buildings
Comment:		The panels are restricted by this Standard in some cases, with reference to clauses 2.6.4 ⁽¹⁾⁽²⁾ , 2.6.5 ⁽¹⁾ and 2.6.6 ⁽²⁾ . See sections 7.1, 7.3, 7.5, 7.7, 7.8, 7.10 and 7.11 of this Certificate.
Standard:	2.7	Spread on external walls
Comment:		The panels are restricted by this Standard in some cases, with reference to clause 2.7.1 ⁽¹⁾⁽²⁾ . See sections 7.1, 7.3, 7.5, 7.7, 7.8, 7.10 and 7.11 of this Certificate.
Standard:	3.10	Precipitation
Comment:		The systems will contribute to satisfying this Standard, with reference to clauses 3.10.1 ⁽¹⁾⁽²⁾ , 3.10.3 ⁽¹⁾⁽²⁾ , 3.10.5 ⁽¹⁾⁽²⁾ and 3.10.6 ⁽¹⁾⁽²⁾ . See section 8 of this Certificate.
Standard:	7.1(a)(b)	Statement of sustainability
Comment:		The systems can contribute to meeting the relevant requirements of Regulation 9, Standards 1 to 6 and therefore will contribute to a construction meeting a bronze level of sustainability as defined in this Standard. (1) Technical Handbook (Domestic). (2) Technical Handbook (Non-Domestic).



The Building Regulations (Northern Ireland) 2012 (as amended)

Regulation:	23	Fitness of materials and workmanship
Comment:		The systems are acceptable. See section 10 and the <i>Installation</i> part of this Certificate.
Regulation:	28(b)	Resistance to moisture and weather
Comment:		The systems will contribute to satisfying this Regulation. See section 8 of this Certificate.
Regulation:	30	Stability
Comment:		The systems are acceptable as set out in sections 4.3 and 6.1 to 6.11 of this Certificate.
Regulation:	35(4)	Internal fire spread – Structure
Comment:		The panels are restricted by this Regulation. See section 7.2 of this Certificate.
Regulation:	36(a)	External fire spread
Comment:		The panels are restricted by this Regulation in some cases. See sections 7.1, 7.3, 7.5, 7.6 and 7.9 of this Certificate.

Information in this Certificate may assist the client, designer (including Principal Designer) and contractor (including Principal Contractor) to address their obligations under these Regulations.

See sections: 1 Description (1.2) and 3 Delivery and site handling (3.5) of this Certificate.

Additional Information

NHBC Standards 2017

In the opinion of the BBA, ALUCOBOND Cladding Systems, if installed, used and maintained in accordance with this Certificate, can satisfy or contribute to satisfying the relevant requirements in relation to *NHBC Standards*, Chapter 6.9 *Curtain walling and cladding*.

Technical Specification

1 Description

General

1.1 ALUCOBOND Cladding Systems comprises ALUCOBOND composite panels attached to an aluminium sub-frame secured to external walls.

Panels

1.2 The ALUCOBOND cladding panels are available in three grades and two styles (see Table 1) and consist of a core layer bonded either side to aluminium outer skins. The panels are available in various thicknesses and colours.

Table 1 ALUCOBOND composite panels

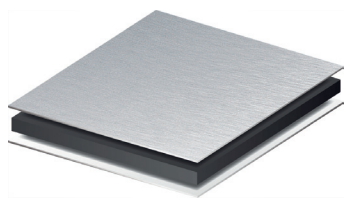
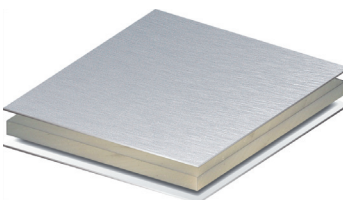
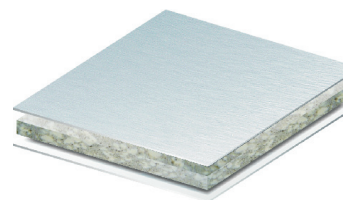
Characteristic (unit)	Panel type		
	ALUCOBOND PE	ALUCOBOND Plus	ALUCOBOND A2
			
Core	Low-density polyethylene (LDPE)	Thermo-plastically bonded aluminium hydroxide	Inorganic filler materials with thermoplastic binder
Length (mm) ⁽¹⁾	3200,4000	3200,4000	3200,4000
Width (mm)	1000,1250,1500 ⁽²⁾	1000,1250,1500 ⁽²⁾	1250,1500 ⁽³⁾
Thickness (mm)	3, 4 and 6	3 and 4	3 and 4
Density (kg·m ⁻³)	900-940	1600-1800	1600-1800
Core colour	Black	Grey	Grey/white

(1) Lengths up to 8000 mm available on request.

(2) 1750 mm width available on request.

(3) 1650 mm width available on request.

1.3 The panel outer skins consist of 0.5 mm thick aluminium sheets manufactured from aluminium alloys EN AW-5005 or EN AW-3003, EN AW-3005, EN AW 3105 as per BS EN 485-2 : 2008 (bare anodised) or BS EN 1396 : 2007 (coated) with properties shown in Table 2. The external face of one or both sides of the skin may be plain, anodised (20 µm thick), primed (for post paint finish), or pre-painted with either 25 µm minimum coating of polyester paint, or polyvinylidene fluoride (PVDF) protective coating.

Table 2 Aluminium sheet properties

Property (unit)	Value
E modulus (E) (N·mm ⁻²)	≥70,000
Tensile strength (R _m) (N·mm ⁻²)	≥130
0.2% proof strength (R _{p0.2}) (N·mm ⁻²)	≥90
Elongation at break (A ₅₀ mm) (%)	≥5

1.4 The panels may be used as flat panels or tray panels (ie folded flat panels produced in the factory by routing out the inner face and most of the core, down the length of a panel, and then bending to shape). Where necessary, the flat panels can be bent to form corner panels and trims for use around openings and installation perimeters. The panels can also be fabricated into bespoke shapes and profiles when required⁽¹⁾.

(1) Outside the scope of this Certificate.

1.5 Flat panels are riveted around the perimeter to the vertical support rails and cross-member bracing (see Figure 1a). The vertical support rails are bolted to the wall brackets and fixed to the substrate.

1.6 Fabricated cassette tray panels are either hung from (see Figure 1b), or mechanically-fixed to (see Figure 1c), vertical support rails using mounting bolts/rivets and fascia screws respectively.

1.7 The panels are strengthened at the fixing points; tray panels incorporate corner sheet plates riveted to the side corners of the panel, and also include a continuous vertical section riveted to the tray side. In addition, horizontal aluminium reinforcing profiles fastened with rivets along the top and bottom of the tray panels for lateral stability may be required (see section 6).

Support system

1.8 The panels are supported to the substrate via an aluminium sub-frame system comprising rail and wall brackets fixed to the substrate. The specifications of fasteners and support rails are given in Table 3.

<i>Table 3 Fastener/rail system details</i>	
Type/system	Description
Flat panel	
Wall bracket	Specified on project basis by a suitably qualified and experienced individual
Vertical support rail and cross-member section	Minimum 1.6 mm thick aluminium alloy 6000 series T- or L-shaped profile (eg EN AW 6060 or EN AW 6063 to BS EN 573-3 : 2003) mill finish or powder-coated
Rail/bracket fixing	5 mm diameter shank blind rivet (aluminium) or self-drilling screw minimum 4.8 mm diameter stainless steel (grade 1.4301 material)
Sub-frame rivet (cross member to rail)	6 mm diameter head with 3 mm diameter shank; aluminium with stainless steel mandrel
Rivets (panel to rail/cross member)	11, 14 or 16 mm head diameter with 5 mm diameter shank; aluminium body with stainless steel mandrel or aluminium pop rivet with steel mandrel which pops out on application
Tray panel (mounting)	
Wall bracket	Specified on project basis by a suitably qualified and experienced individual
Vertical support rail	Minimum 1.6 mm aluminium alloy (6000 series) U profile (eg EN AW 6060 or EN AW 6063 to BS EN 573-3 : 2003) mill finish or powder-coated
Corner sheet (reinforcement)	Minimum 2 mm thick aluminium alloy EN AW 5754
Rivets (corner sheet to panel)	11, 14 or 16 mm head diameter with 5 mm diameter shank; aluminium body with stainless steel mandrel or aluminium pop rivet with steel mandrel which pops out on application
Bolt mountings	10 mm diameter stainless steel (grade 1.4301 material)
Tray panel (mechanically fastened)	
Wall bracket	Specified on project basis by a suitably qualified and experienced individual
Vertical support rail	Minimum 1.6 mm aluminium alloy (6000 series) U profile (eg EN AW 6060 or EN AW 6063 to BS EN 573-3 : 2003) mill finish or powder-coated
Vertical section (reinforcement)	Minimum 1.6 mm aluminium alloy (6000 series) profile systems (as shown in Figure 1)
Rivets (panel to vertical section)	11, 14 or 16 mm head diameter with 5 mm diameter shank; aluminium body with stainless steel mandrel or aluminium pop rivet with steel mandrel which pops out on application
Mounting bracket	2 mm thick aluminium alloy (5000 series) (optional, used to carry dead load)
Fascia screw (vertical section to support rail)	4.8 mm diameter self drilling screw, stainless steel (grade 1.4301 material)
Clamping washer (edge grip system)	Screwed to the vertical support rail

Figure 1 Fixing system details

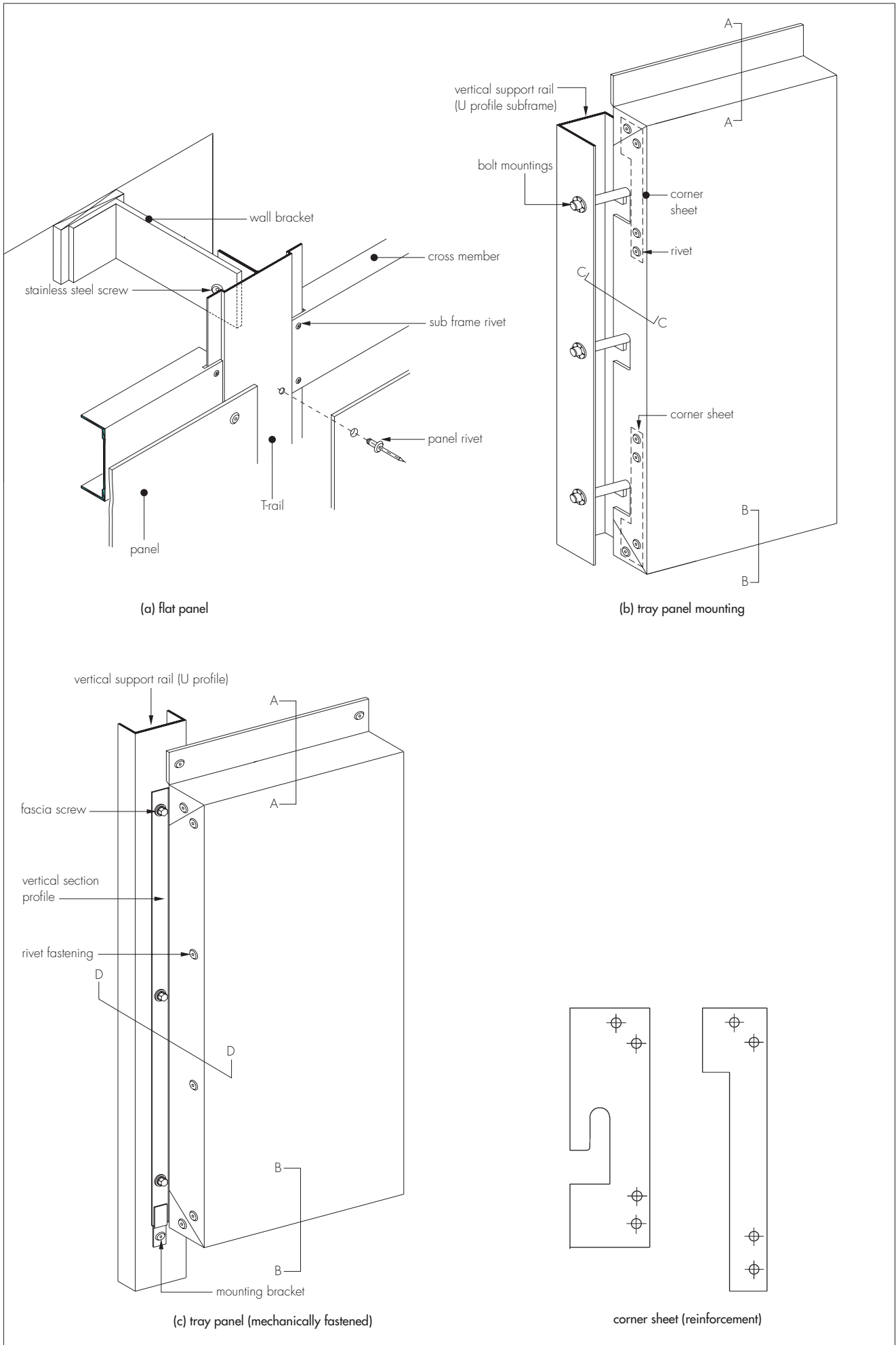
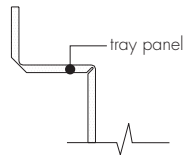

Figure 1 Fixing system details (continued)

profiles (without reinforcement)

section A-A



section B-B

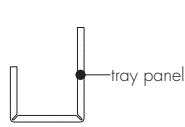

section C-C

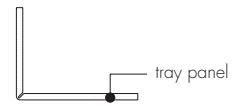

reinforced profiles (options)

section A-A

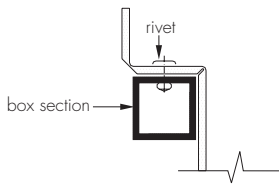

section B-B

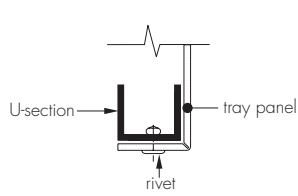

section C-C

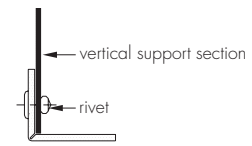

section B-B

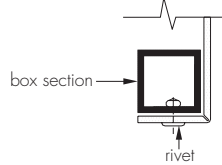

section C-C

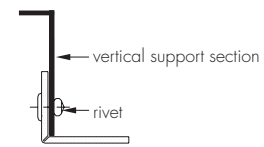

section B-B

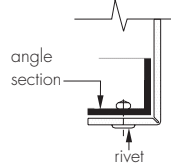

section D-D (tray panel – mechanically fastened only)

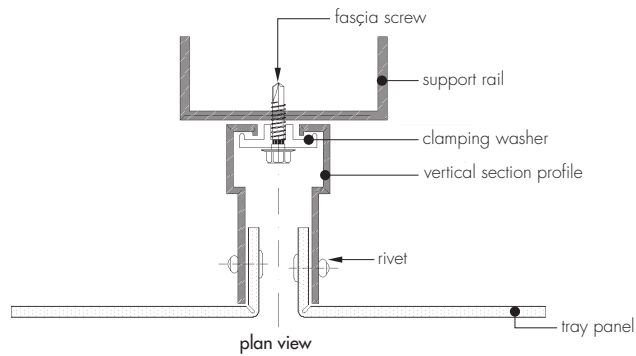
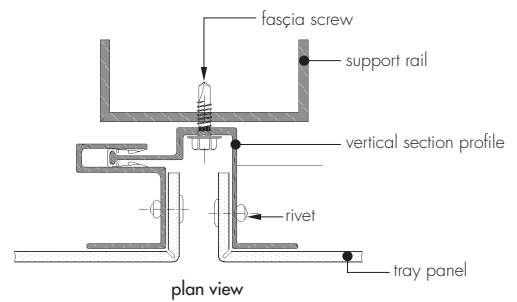
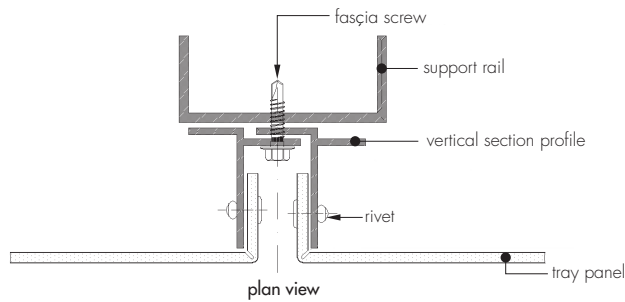

1.9 Ancillary items used with the systems but outside the scope of this Certificate include:

- substrate wall — masonry, steel and timber frame
- wall bracket — used to fix sub-frame to wall
- wall bracket fixing — used to fix bracket to the wall
- insulation — where specified
- cavity barriers.

2 Manufacture

2.1 The panels are produced in a continuous process by extruding the core between two aluminium sheets during which the core hot-melt bonds to the aluminium.

2.2 Tray panels are folded into shape by routing the inner face and core section and include a vertical profiled section riveted to the side.

2.3 As part of the assessment and ongoing surveillance of product quality, the BBA has:

- agreed with the manufacturer the quality control procedures and product testing to be undertaken
- assessed and agreed the quality control operated over batches of incoming materials
- monitored the production process and verified that it is in accordance with the documented process
- evaluated the process for management of nonconformities
- checked that equipment has been properly tested and calibrated
- undertaken to carry out the above measures on a regular basis through a surveillance process, to verify that the specifications and quality control operated by the manufacturer are being maintained.

2.4 The management system of 3A Composites GmbH has been assessed and registered as meeting the requirements of BS EN ISO 9001 : 2008, BS EN ISO 14001 : 2004 and OHSAS 18001 : 2007 by DEKRA Certification GmbH (Certificates 80605630, 17060574 and 270605009 respectively).

3 Delivery and site handling

3.1 The panels are delivered to site stacked on pallets with a protective polythene film covering the external face. For reflective finishes (ie metallic-coloured panels and anodised panels), the protective film bears an arrow to enable correct alignment during installation. Additional arrows are printed on the rear side of the panels.

3.2 The pallets should be stored on a dry, flat and level surface in stacks not exceeding 2 m high and suitably protected from the weather. The protective film on the panels should be removed as soon after installation as possible.

3.3 Each pallet carries a label bearing the product identification and order number.

3.4 The panels should be handled with care to avoid damage. They should be lifted off, rather than slid across each other.

3.5 Care should be exercised when handling the panels to avoid injury from sharp edges. Protective clothing should be worn and normal Health and Safety precautions observed.

Assessment and Technical Investigations

The following is a summary of the assessment and technical investigations carried out on ALUCOBOND Cladding Systems.

Design Considerations

4 General

4.1 ALUCOBOND Cladding Systems are suitable for conversion into factory-produced cladding cassettes, or may be used as flat sheet, for non-load bearing external cladding fixed to aluminium sub-frames designed in accordance with BS EN 1999-1-1 : 2007 and BS EN 1999-1-4 : 2007.

4.2 The panels are satisfactory for use in an open-jointed, back-ventilated and drained cladding system on the external walls of new and existing buildings, however, height restrictions may apply (see section 7). All ventilation openings should be suitably protected, or baffled, to prevent the ingress of birds, vermin and rain (see section 8).

 4.3 The wall and the sub-frame to which the cladding is fixed should be structurally sound and constructed in accordance with the requirements of the relevant national Building Regulations and Standards.

4.4 The supporting wall to which the cladding is fixed should be airtight and resistant to the transmission of heat and sound.

4.5 To allow for longitudinal expansion, a gap of minimum 10 mm between adjacent support rails should be provided. The cladding panels must not straddle this gap.

5 Practicability of installation

The systems are designed to be installed by installers who have been trained and approved by the Certificate holder.

6 Strength and stability



6.1 All design aspects of the installation should be checked by a suitably qualified and experienced individual. Specific construction details can be obtained from the Certificate holder.

Wind loading

6.2 Design wind loads should be calculated in accordance with BS EN 1991-1-4 : 2005. Due consideration should be given to the higher-pressure coefficients applicable to corners of the building as recommended in this Standard.

6.3 The supporting wall must be able to take the full wind load, as well as any racking loads, on its own. No contribution from the cladding may be assumed in this regard.

6.4 The designer must ensure the fixing of the wall bracket to the substrate has adequate pull-out resistance for the calculated loads.

6.5 For design purposes, the panel properties given in Table 4 may be adopted.

Table 4 Panel properties⁽¹⁾

Panel thickness (mm)	Section modulus (Z) (cm ³ ·m ⁻¹)	Flexural rigidity (EI) (Nm ² ·m ⁻¹)
3	1.25	125
4	1.75	240
6	2.75	590

(1) The maximum panel centre deflection will be governed by specific project requirements but should not exceed 1/30 of the diagonal formed by the four adjacent fixings or 50 mm, whichever is the lesser.

6.6 The suitability of tray panels and their fixing mechanisms must be verified using the information in Table 4 by a suitably qualified and experienced individual. For design purpose, tray panel mounting data given in Figure 2 may be used.

Figure 2 Tray panel mounting load resistance

Permissible design load F for

- ALUCOBOND, all thicknesses
- Aluminium reinforcement (EN AW-5005)
- hooked on stainless steel bolt $\varnothing 10$ (including: safety factor 3 and 3 mm eccentricity)

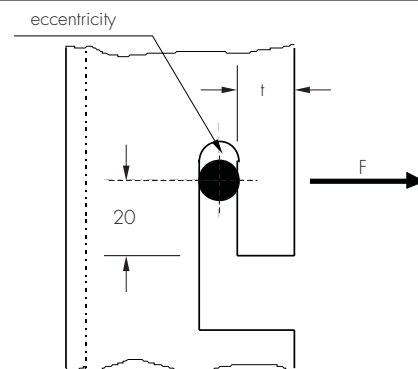

Material	hook t (mm)	load F (kN)
ALUCOBOND	15	0.35
ALUCOBOND	20	0.40

Al-sheet, 2 mm	10	0.45
Al-sheet, 2 mm	15	0.75
Al-sheet, 3 mm	10	0.65
Al-sheet, 3 mm	15	1.10

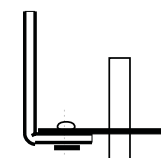
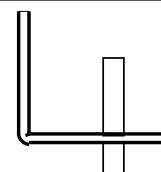

6.7 Rivets and bolts should be used to attach the panels to the support frame. The design should ensure adequate capacity against wind pressure/suction. To allow for panel expansion, fixings in clearance holes should be provided with a minimum of 1 mm clearance.

6.8 The maximum allowable wind pressure/suction will be the lesser value obtained by considering the panels and fixings separately.

6.9 The wind loads that may be taken by the flat panels are dependent upon the panel size as shown in Table 5. The load tables are based on the following data:

- all four sides supported edges fixed
- permissible design stress for the aluminium outer skins equals 51 N·mm⁻² (safety factor $[\gamma_f \times \gamma_m]$ ⁽¹⁾ of 3.0 regarding ultimate failure, and 1.75 regarding permanent deformation)

- panel flexural rigidity values EI as per Table 4
- permissible design loads for 5 mm fastening rivets (safety factor 3):
 - in shear $R_c = 720$ N
 - in tension $R_t = 680$ N
- interaction between shear and tensile loads is given by:

$$\frac{F_c}{R_c} + \frac{F_t}{R_t} \leq 1.0$$

where F_c and F_t are the applied shear and tensile loads respectively

- fastening clearance, diameter of hole minus diameter of rivet, equals 2 mm
- minimum drilling margin at edge of panel equals 15 mm
- permissible deflection of sub-frame $\leq 1/200$ of vertical span between wall brackets.

(1) γ_f = partial factor for actions, γ_m = partial factor for material property.

Table 5 ALUCOBOND flat panel load deflection values

Load (Pa)	ALUCOBOND 3 mm								
	W = 625 mm			W = 750 mm			W = 1000 mm		
	L (mm)	f (mm)	Spacing (mm)	L (mm)	f (mm)	Spacing (mm)	L (mm)	f (mm)	Spacing (mm)
500	8000	8	500	8000	16	500	3800	44	500
600	8000	9	500	8000	19	500	3300	43	500
700	8000	10	500	8000	23	500	3000	42	500
800	8000	12	500	8000	26	500	2800	40	500
900	8000	14	500	8000	29	500	2600	38	500
1000	8000	15	500	8000	32	500	2450	36	500
1100	8000	17	500	3200	33	500	2050	32	500
1200	8000	18	500	2800	32	500	1800	28	500
1400	8000	22	500	2500	31	500	1450	24	500
1600	8000	24	500	2200	30	500	1200	21	500
1800	2200	23	500	1600	23	500	1050	19	500
2000	1900	23	500	1350	20	500	925	18	500
2200	1750	22	500	1200	18	500	825	17	500
2400	1500	21	500	1050	16	500	750	16	500
2600	1250	18	500	950	15	500	700	16	500
2800	1100	16	500	850	14	500	650	15	400
3000	1000	15	500	800	13	500	600	14	400

	ALUCOBOND 4 mm								
	W = 1000 mm			W = 1250 mm			W = 1500 mm		
	L (mm)	f (mm)	Spacing (mm)	L (mm)	f (mm)	Spacing (mm)	L (mm)	f (mm)	Spacing (mm)
500	8000	26	500	3800	35	500	3400	43	500
600	8000	32	500	3300	38	500	3000	42	500
700	8000	37	500	3000	38	500	2700	41	500
800	3700	37	500	2800	37	500	2300	36	500
900	3300	35	500	2500	36	500	2000	32	500
1000	3000	34	500	2300	35	500	1800	30	500
1100	2700	33	500	2000	31	500	1600	28	500
1200	2400	31	500	1800	28	500	1500	27	500
1400	2100	30	500	1500	25	500	1250	25	500
1600	1700	25	500	1300	23	500	1100	24	500
1800	1400	22	500	1100	21	500	1000	23	500
2000	1200	20	500	1000	20	500	900	22	400
2200	1100	18	500	900	19	500	800	21	400
2400	1000	17	500	800	18	400	750	20	300
2600	900	16	500	750	18	400	700	19	300
2800	800	15	400	700	17	300	650	18	300
3000	750	15	400	650	16	300	600	15	300

Notes:

For the 6 mm panels, the designer may use the panel properties given in Table 4 to verify load/span characteristics.

Key:

L = length, W = width

f = elastic deflection

Spacing = maximum spacing of rivets.

6.10 For guidance, the panel deflection should be taken as $L/100$ as this may be more appropriate for aesthetic reasons. However, the deflection (as given in Table 5) will not result in failure or permanent deflection.

6.11 The designer should ensure the following:

- the system is designed to adequately resist the wind loads likely to be experienced in the UK
- fixing of the sub-frame to the substrate wall has adequate pull-out resistance (outside the scope of this Certificate) for the calculated loads.

Impact

6.12 The systems are suitable for use in locations where there is little possibility of impact or abrasion damage under Use Categories II, III and IV defined in Table 4 of ETAG 034 : 2012, Part 1 (reproduced in Table 6 of this Certificate).

Table 6 Definition of Use Categories (reproduced from ETAG 034, Part 1, Table 4)

Use Category	Description
I	A zone readily accessible at ground level to the public and vulnerable to hard body impacts but not subjected to abnormally rough use.
II	A zone liable to impacts from thrown or kicked objects, but in public locations where the height of the kit will limit the size of the impact; or at lower levels where access to the building is primarily to those with some incentive to exercise care.
III	A zone not likely to be damaged by normal impacts caused by people or by thrown or kicked objects.
IV	A zone out of reach from ground level.

7 Behaviour in relation to fire



7.1 The external surface of the flat panels have the reaction to fire classifications shown in Table 7. The reaction to fire classification of cassette formats of the panels and specific build-ups may be different and must be confirmed by an appropriately qualified fire expert, or testing at a laboratory accredited by the United Kingdom Accreditation Service (UKAS) or other mutually recognised accreditation scheme.

Table 7 Reaction to fire classifications of flat panels to BS EN 13501-1 : 2007

Product	Thickness (mm)	Classification	Report reference ⁽¹⁾
Alucobond A2	3 and 4	A2-s1, d0 ⁽²⁾⁽³⁾	MPA 902 8145 000-81, dated 14 November 2014
Alucobond Plus	3 and 4	B-s1, d0 ⁽⁴⁾⁽⁵⁾	MPA 902 8415 000-82, dated 13 March 2015
Alucobond PE	3 and 4 ⁽⁶⁾	D-s2, d2 ⁽⁴⁾⁽⁵⁾	MPA 900 6717 014-80, dated 22 July 2014

(1) Copies are available from the Certificate holder on request.

(2) Covers flat panels with air gaps >30 mm behind the panels and gaps <20 mm between panel edges and riveted to a metal sub frame.

(3) Testing and assessment indicates a preliminary A-s1, d0 classification for Alucobond A2 panels in cassette format. Users should refer to IBS Project No 319043006-1-en report, dated 27 May 2019 for specific details of the tested construction.

(4) Covers flat panels with air gaps >30 mm behind the panels and gaps <15 mm between panel edges and riveted to a metal sub frame.

(5) Testing and assessment indicates a preliminary B-s1, d0 classification for Alucobond Plus panels in cassette format. Users should refer to IBS Project No 315121602-A-en report, dated 9 June 2016 for specific details of the tested construction.

(6) The classification of Alucobond PE at 6 mm thickness is not covered by this Certificate and should be confirmed by assessment or testing by a suitably accredited laboratory.

7.2 The reverse side of the panels (facing into the cavity) has not been classified. Cavity barriers should be provided in accordance with the requirements of the documents supporting the national Building Regulations taking this into account.

7.3 The fasteners and rails are classified as non-combustible in accordance with the documents supporting the national Building Regulations.

7.4 Designers should refer to the relevant national Building Regulations and guidance for alternative approaches and detailed conditions of use, particularly in respect of requirements for substrate fire performance, fire stopping, cavity barriers, service penetrations and combustibility limitations for other materials and components used in the overall wall construction, for example, thermal insulation.

Alucobond A2



7.5 Flat and cassette panels, fasteners and rails are not subject to any restriction on building height or proximity to boundaries.

Alucobond Plus



7.6 In England, Wales and Northern Ireland, the flat panels are not classified as non-combustible or of limited combustibility and may be used on buildings with no storey 18 m or more above the ground and 1 m or more from a boundary.



7.7 In Scotland, the flat panels are not classified as non-combustible, and may be used on buildings more than 1 m from a boundary and, on houses, 1 m or less from a boundary. With minor exceptions, the panels should be included in calculations of unprotected area, except on houses where the external wall has the appropriate fire resistance.

7.8 In Scotland, the panels should not be used on any building with a storey more than 11 m above the ground, or on any entertainment or assembly building with a total storey area more than 500 m², or on any hospital or residential care building with a total storey area more than 200 m².

Alucobond PE



7.9 In England, Wales and Northern Ireland, the flat panels are not classified as non-combustible and may be used on buildings with no storey 18 m or more above the ground and 1 m or more from a boundary. With minor exceptions, the panels should be included in calculations of unprotected area.



7.10 In Scotland, the flat panels are not classified as non-combustible and may be used on buildings more than 1 m from a boundary. With minor exceptions, the panels should be included in calculations of unprotected area.

7.11 In Scotland, the panels should not be used on any building with a storey more than 11 m above the ground, or on any entertainment or assembly building with a total storey area more than 500 m², or on any hospital or residential care building with a total storey area more than 200 m².

8 Air and water penetration



8.1 The panels are suitable for use in back-ventilated and drained cladding systems.

8.2 The supporting wall must be watertight and reasonably airtight.

8.3 The systems are not sealed, (ie gaps between panels are minimum 10 mm) but any water entering the cavity behind the cladding by wind-driven rain or condensation will be minimal and removed by drainage and ventilation.

8.4 The air space between the back of the panels and the supporting wall must be a minimum 20 mm while allowing for conventional building tolerances. The ventilation pathway behind the cladding must not be allowed to become blocked and openings should be suitably protected, or baffled, to prevent the ingress of birds, vermin and rain.

9 Maintenance



9.1 Soiled panels can be cleaned using a soft cloth or sponge with warm soapy water or detergents, or with a proprietary cleaner recommended by the manufacturer. Strong acids/alkalis and harsh abrasives should not be used.

9.2 Annual maintenance inspections should be carried out to ensure that rainware is complete and in good order, and that such features as tiles, flashings and seals are in place and fixings are secure.

9.3 Damaged panels should be replaced as soon as is practicable; work carried out should follow the Certificate holder's instructions and all necessary Health and Safety regulations should be observed.

10 Durability



10.1 The systems will perform effectively as a cladding with an ultimate life of at least 30 years.

10.2 The performance of the coating will depend upon the type, colour chosen, building location, façade aspect and the immediate environment.

10.3 In a non-corrosive atmosphere, the panels can be expected to retain a good appearance for up to 20 years in typical locations, and 15 years in coastal or severe industrial regions. Colour change will be generally small and uniform on any one elevation. Regular maintenance (see section 9), will prolong the aesthetic appearance of the panels.

11 Re-use and recyclability

The panels comprise materials which can be recycled.

Installation

12 General

12.1 ALUCOBOND Cladding Systems must be installed in accordance with the Certificate holder's recommendations, the requirements of this Certificate and specifications laid down by a suitably qualified and experienced individual.

12.2 Installers must be trained and approved by the Certificate holder who can provide technical assistance at the design stage and at the start of the installation.

12.3 Installation should not be carried in extremes of temperature. It is recommended that it takes place at temperatures of between 5°C and 25°C.

12.4 The panels must be mounted to allow for thermal expansion movement. When flat panels and mechanically fixed tray panels are installed, allowance for expansion is made by the appropriate use of clearance holes at fixings. Rivets are centrally placed in oversized drill holes with a minimum 1 mm clearance around the 5 mm rivet, with a rivet head overlap of a minimum 1 mm onto the panel.

12.5 The panels can be worked by conventional techniques in accordance with the Certificate holder's instructions. These include sawing and cutting, routing, slotting, folding, drilling, bending, clamping and bolting, shearing and riveting. It is essential that the correct tools, in good condition, are used to prevent any damage to the coating, and that swarf is removed.

12.6 The panels may be fabricated for installation in either the vertical or horizontal plane. Corner and other bent panels may be prepared in the factory or on site. The panels may be pre-drilled in the factory or on site.

12.7 Suitable cavity barriers, as described in section 7.9, should be installed behind the cladding as necessary, to comply with the relevant national Building Regulations relating to fire safety.

13 Procedure

Flat panels (see Figure 2)

Figure 2 Typical installation detail

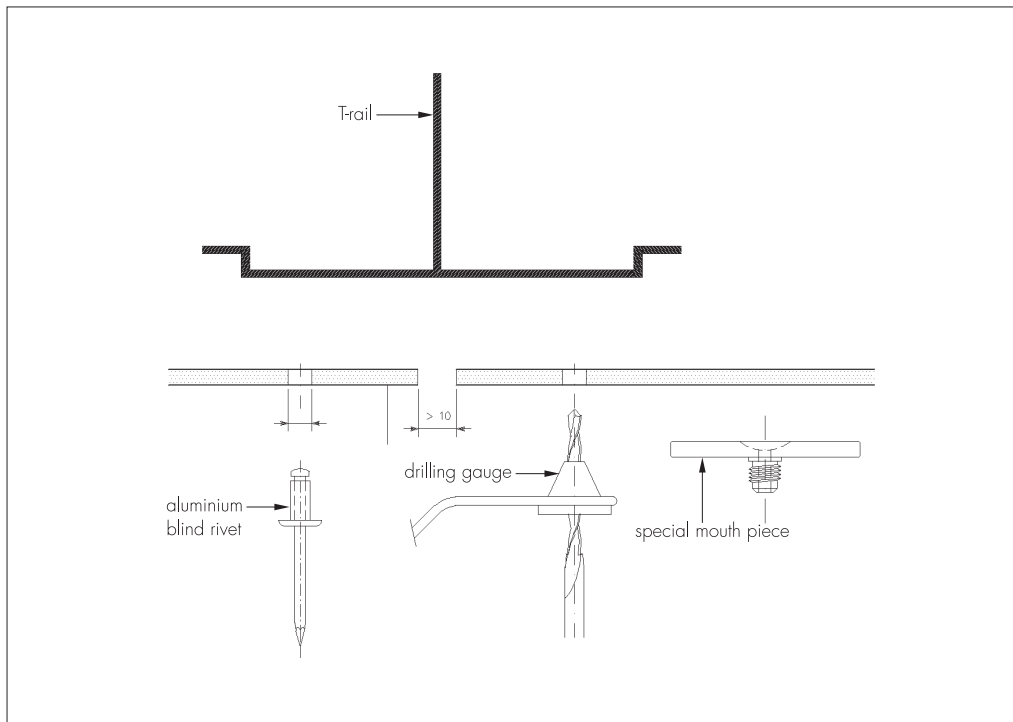

13.1 Wall brackets are fixed to the substrate using appropriate fixings. Vertical spacing between wall brackets should be as specified.

13.2 Vertical support rails are fixed to the brackets with the top fixing tight and the remainder of the fixings sufficiently free to allow for movement (ie a minimum 10 mm). In addition, an expansion gap between adjacent vertical rails must be a minimum 10 mm for standard 6 m lengths of rail.

13.3 Cross-member sections are riveted to the rails. The cross member should not be butted tightly between rails, to allow for some minimal expansion of this section.

13.4 The panels must be aligned in accordance with the directional arrow (where indicated) on the protective film which must be removed only after installation.

13.5 The panels are riveted around their perimeter to rails and cross-members with a minimum 10 mm gap between panels. Rivets are fixed commencing at the middle of each side working to the corners at spacings of a maximum 500 mm along the supporting rails ensuring a minimum edge distance of 15 mm. The top and bottom of adjacent panels must be fixed to separate L-shaped cross-members at breaks between Trails.

Tray panels

13.6 Wall brackets are fixed to the substrate using appropriate fixings with vertical spacing between wall brackets as specified.

13.7 Rails are fixed to the brackets with the top fixing tight and the remainder of the fixings sufficiently free to allow for movement (ie a minimum 10 mm). In addition, an expansion gap between adjacent vertical rails must be a minimum 10 mm for standard 6 m lengths of rail.

13.8 The tray panels are fabricated as per the design requirements and layout as shown in Figure 1.

13.9 For mounted installation, the panels are hooked onto the bolts with the machined notched slots ensuring a minimum 10 mm gap between panels.

13.10 For mechanically fixed panels, the panel is fixed to the vertical support rail using rivets commencing at the middle of each side working to the corners at spacing of maximum 500 mm along the supporting rails ensuring a minimum edge distance of 15 mm.

13.11 The panels must be aligned in accordance with the directional arrow on the protective film which must be removed only after installation.

14 Finishing

14.1 The systems should be left open at the top, protected with an overhanging trim or bent panel.

14.2 The systems should be closed at the sides with appropriate panel work or trims.

14.3 A perforated base plate should be installed at the bottom of the installation, permitting adequate ventilation as specified in section 8 but preventing the intrusion of rodents.

Technical Investigations

15 Investigations

15.1 Based on independent test data, an assessment was made of:

- performance under wind loads
- impact strength
- material characteristics
- resistance to wind
- impact loading
- durability.

15.2 The manufacturing process was evaluated, including the methods adopted for quality control, and details were obtained of the quality and composition of the materials used.

15.3 From test data, an assessment was made of the system's behaviour in relation to fire.

Bibliography

BRE Report BR 135 : 2003 *Fire Performance of external thermal insulation for walls of multistorey buildings*

BS 8414-1 : 2015 + A1 : 2017 *Fire performance of external cladding systems — Test method for non-loadbearing external cladding systems applied to the masonry face of a building*

BS 8414-2 : 2015 + A1 : 2017 *Fire performance of external cladding systems — Test method for non-loadbearing external cladding systems fixed to and supported by a structural steel frame*

BS EN 485-2 : 2008 *Aluminium and aluminium alloys — Sheet, strip and plate — Mechanical properties*

BS EN 573-3 : 2003 *Aluminium and aluminium alloys — Chemical composition and form of wrought products — Chemical composition and form of products*

BS EN 1396 : 2007 *Aluminium and aluminium alloys — Coil coated sheet and strip for general applications — Specifications*

BS EN 1991-1-4 : 2005 *Eurocode 1 : Actions on structures — General actions — Wind actions*

BS EN 1999-1-1 : 2007 *Eurocode 9 : Design of aluminium structures — General structural rules*

BS EN 1999-1-4 : 2007 *Eurocode 9. Design of aluminium structures. Cold-formed structural sheeting*

BS EN 13501-1 : 2007 *Fire classification of construction products and building elements — Classification using test data from reaction to fire tests*

BS EN ISO 9001 : 2008 *Quality management systems — Requirements*

BS EN ISO 14001 : 2004 *Environmental management systems — Requirements with guidance for use*

ETAG 034-1 : 2012 *Guideline for European Technical Approval of Kits for External Wall Claddings*

OHSAS 18001 : 2007 *Occupational Health and Safety Management (OHS)*

16 Conditions

16.1 This Certificate:

- relates only to the product/system that is named and described on the front page
- is issued only to the company, firm, organisation or person named on the front page — no other company, firm, organisation or person may hold or claim that this Certificate has been issued to them
- is valid only within the UK
- has to be read, considered and used as a whole document — it may be misleading and will be incomplete to be selective
- is copyright of the BBA
- is subject to English Law.

16.2 Publications, documents, specifications, legislation, regulations, standards and the like referenced in this Certificate are those that were current and/or deemed relevant by the BBA at the date of issue or reissue of this Certificate.

16.3 This Certificate will remain valid for an unlimited period provided that the product/system and its manufacture and/or fabrication, including all related and relevant parts and processes thereof:

- are maintained at or above the levels which have been assessed and found to be satisfactory by the BBA
- continue to be checked as and when deemed appropriate by the BBA under arrangements that it will determine
- are reviewed by the BBA as and when it considers appropriate.

16.4 The BBA has used due skill, care and diligence in preparing this Certificate, but no warranty is provided.

16.5 In issuing this Certificate, the BBA is not responsible and is excluded from any liability to any company, firm, organisation or person, for any matters arising directly or indirectly from:

- the presence or absence of any patent, intellectual property or similar rights subsisting in the product/system or any other product/system
- the right of the Certificate holder to manufacture, supply, install, maintain or market the product/system
- actual installations of the product/system, including their nature, design, methods, performance, workmanship and maintenance
- any works and constructions in which the product/system is installed, including their nature, design, methods, performance, workmanship and maintenance
- any loss or damage, including personal injury, howsoever caused by the product/system, including its manufacture, supply, installation, use, maintenance and removal
- any claims by the manufacturer relating to CE marking.

16.6 Any information relating to the manufacture, supply, installation, use, maintenance and removal of this product/system which is contained or referred to in this Certificate is the minimum required to be met when the product/system is manufactured, supplied, installed, used, maintained and removed. It does not purport in any way to restate the requirements of the Health and Safety at Work etc. Act 1974, or of any other statutory, common law or other duty which may exist at the date of issue or reissue of this Certificate; nor is conformity with such information to be taken as satisfying the requirements of the 1974 Act or of any statutory, common law or other duty of care.