



Instruction Guide

Guidelines for processing and
installation of external cladding

Rockpanel®
a **ROCKWOOL** company

NOTES

TABLE OF CONTENTS

GENERAL	4
ROCKPANEL® BOARDS	4
ROCKPANEL® BOARDS - IT IS POSSIBLE!	6
PROCESSING	8
PACKAGING, TRANSPORT AND STORAGE	8
WORKING WITH ROCKPANEL BOARDS	10
SUB FRAME	14
JOINTS AND BOARD CONNECTIONS	19
FIXING	22
DISTANCES BETWEEN FASTENING POINTS	27
MAINTENANCE	37
DETAILING	38
FACADE	38
ROOFLINE	41
DETAILING	43
NON-VENTILATED APPLICATIONS	46
STANDARD RANGE AND AVAILABILITY	47
BOARDS	47
ACCESSORIES	49
PRODUCT PROPERTIES	52
CERTIFICATES AND APPROVALS	53
MORE INFORMATION	54

GENERAL

ROCKPANEL® BOARDS

The ROCKPANEL Group is part of ROCKWOOL® International A/S. The company manufactures board material for exterior cladding from the sustainable resource, basalt rock. ROCKPANEL products combine all the benefits of stone and wood.

Where other board materials fail, ROCKPANEL boards succeed. It's quick and easy to work, durable and attractive - which is why we say: ROCKPANEL boards; It is possible!

ROCKPANEL board material is ideally suited to both new build and renovation projects in areas such as:

- facades;
- roofline applications: like roof edging, projections, gutter finishing, dormers, fascia boards or parapets;
- other detailing such as on soffits, entrances and infill panels.

Certification and warranties

The ROCKPANEL Group has been awarded an ETA Certificate (European Technical Assessment). More information about a warranty can be obtained via your ROCKPANEL dealer.

ROCKPANEL grades

The basic board material is available in three different grades:

- **Durable:** for use in regular facade and roofline applications.
- **Xtreme:** for use in facade applications when a greater degree of strength is required. For instance to withstand higher wind loadings or impact resistance.
- **NEW FS-Xtra:** facade cladding in 9 mm thickness for use in facade applications where the greatest degree of fire safety is required. Applied on an aluminium or steel supporting structure and fixed with rivets, the boards can meet the requirements for European fire class A2-s1, d0.

Note: ROCKPANEL Ply is a product in the ROCKPANEL assortment which has other mechanical properties than the Durable, Xtreme and FS-Xtra grades.

Sustainability

The ROCKPANEL Group had the environmental performance of its products assessed by an independent research organisation (BRE Global). On the basis of a Life Cycle Assessment the products were acknowledged as a sustainable building product. A recognition which provides an assurance that ROCKPANEL facade cladding in a sustainable construction project is a responsible choice.

Properties

See page 6 and 7 for all the advantages which ROCKPANEL board material has to offer. A list of product characteristics and technical approvals can be found on pages 52 and 53.

Product range

ROCKPANEL board material is available in a range of different colours and designs. See page 47 and 48 for the standard range.

- **ROCKPANEL Rockclad:** a board available in all RAL/NCS colours.
- **ROCKPANEL Rockclad Bright:** consists of 4 distinctive colours and comes in measurements 8 mm x 1200 mm x 3050 mm.
- **ROCKPANEL Ply:** board material with a primer coat, ready for painting on site.
- **ROCKPANEL Metallics:** facade cladding with a metallic topcoat for a striking industrial character.
- **ROCKPANEL Brilliant:** 16 finishes that sparkle under the effect of light yet harmonise with their environment.
- **ROCKPANEL Chameleon:** extraordinary facade panels which appear to change colour depending on the effect of light and the angle from which it is viewed.
- **ROCKPANEL Woods:** board material for a natural, non repetitive wood grain pattern.
- **ROCKPANEL Natural:** unpainted board material where the colour changes under the influence of natural weathering to grey-brown.
- **ROCKPANEL Lines²:** the Lines² 10 mm tongue-and-groove cladding boards can be mounted in the traditional way, using nails or flat-top screws. Lines² 8 mm can also be fixed in a more innovative way, using the new mounting clip.

ROCKPANEL® BOARDS - IT IS POSSIBLE!



Strong but flexible? It is possible!

ROCKPANEL boards combine the advantages of stone and wood in one product. It is as durable as stone and can be worked as easily as wood. A slightly curved facade can easily be applied.

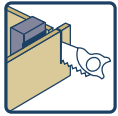

Detailing on the building site? It is possible!

With ROCKPANEL boards you can complete detailing quickly and easily. Detailing, routing and sawing to size? It's so easy. You don't even need to finish the edges to protect them from moisture.



Always in matching colours? It is possible!

The RAL colours of ROCKPANEL boards match window frames or other building elements. Facade finishing and paintwork in compatible RAL colour can therefore give your building a smooth and seamless look.



Colours that stay beautiful? It is possible!

ROCKPANEL board material is colourfast and low-maintenance. Clean once a year with water and the facade looks fresh for years to come!

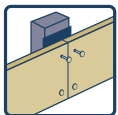

Installing ROCKPANEL boards with nails? It is possible!

You can install the ROCKPANEL boards with nails on the building site. The small nail heads in a compatible RAL colour ensure a beautiful end result.

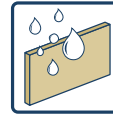

Insensitive to moisture? It is possible!

Edge treatment to protect the edges from moisture is needed with many other board materials or laminates. ROCKPANEL board material is insensitive to moisture and temperature so does not require edge treatment.

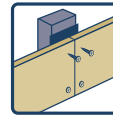

Installing without pre-drilling? It is possible!

With ROCKPANEL boards you save time and money and avoid risks and costly delays. Just install on site without pre-drilling. This ensures fewer mistakes, a better finish and no drilling costs for you to pay.



Truly lightweight? It is possible!

With ROCKPANEL board material you can work more quickly and easily. You can save time and make installation easier for site personnel. The boards are considerably lighter than other board materials. Making a real difference to those installing them!

- ROCKPANEL Durable 6 mm board = 6.3 kg/m²
- ROCKPANEL Durable 8 mm board = 8.4 kg/m²



Working with standard tools? It is possible!

ROCKPANEL board material can be worked using standard tools. It is easier and much faster to work than other board materials. Easy to saw to size and install without pre-drilling again avoiding risks and costly site delays.



A corner solution for every detail? It is possible!

For every corner ROCKPANEL board material offers the right solution. Use a corner profile in exactly the same RAL colour, or simply touch up paint for the edges if required. For the real craftsman you can achieve a perfect corner finish using a mitre saw.

PROCESSING

PACKAGING, TRANSPORT AND STORAGE

General

- ROCKPANEL board material is a decorative external cladding product. Always handle the boards with care.

Storage

- Store the board material in dry, flat, frost-proof and protected conditions;
- Store on flat pallets and place the pallets on a level foundation. Preferably with PE-foil as an underlay;
- Make sure that the board material does not have direct contact with the floor;
- Never stack more than two pallets high;
- During storage, the board material can be more affected by moisture and night-time cooling than when installed. Before installing, the boards will need some time to allow any moisture and condensation to evaporate.

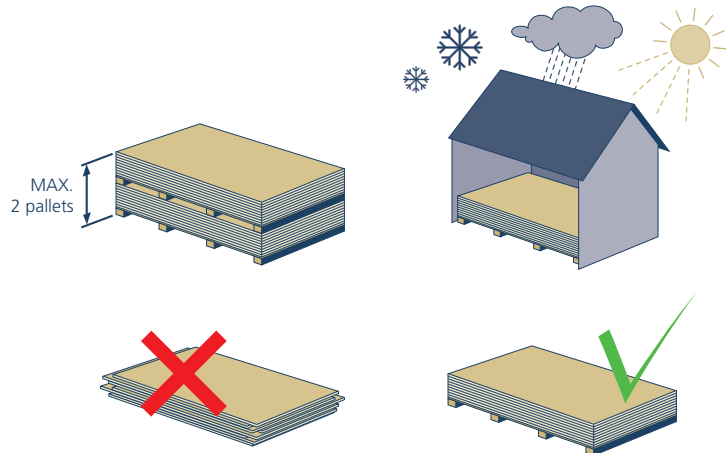

Site handling

- Individual panels must be lifted off the stack, not pulled or pushed, and carried upright;
- Protective foam membranes should be placed between the sheets again to protect the surface layer.

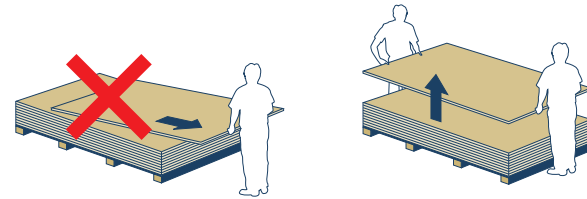

Protective film

- Most boards in the range are covered by a film to protect the decorative finish. Site measurements can also be marked on this film to aid the installation process. ROCKPANEL Natural, ROCKPANEL Lines², ROCKPANEL Metallics (Aluminium White and Aluminium Grey) and ROCKPANEL Ply are delivered without protective film. Handling of these boards needs extra attention.
- Remove the protective film:
 - after mounting, if attaching mechanically with screws or manual nailing;
 - before priming the board for adhesive bonding;
 - before installing when using a pneumatic hammer.

WORKING WITH ROCKPANEL BOARDS

ROCKPANEL board material is a safe product to work with. Produced from basalt, a natural and sustainable volcanic stone. Stone wool is one of the most extensively researched and tested building materials. For additional information see the 'Health and safety' documentation on www.rockpanel.co.uk.

Sawing

Standard tools can be used for sawing ROCKPANEL boards or making cut-outs in the board material. In general the boards should be sawn with the decorative side facing upwards and with the protective film still in place.

Equipment

- Hand saw, e.g. a hard point saw.
- Circular saw, e.g. a fine-toothed Widia saw blade.
- Fretsaw, e.g. a fine-toothed saw blade for metal or a saw blade with tungsten coating.

Safety guidelines

- Use a dust mask (type P2).
- Use standard safety spectacles to protect the eyes from dust.
- Wear gloves during sawing.



Indoor sawing

- Use dust-reducing sawing equipment in combination with an extraction hood in a well-ventilated room.

Outdoor sawing

- Position the saw installation so that the wind blows away any dust from the sawing.
- Use dust-reducing sawing equipment if possible.

Drilling

- Pre-drilling is not necessary with ROCKPANEL board material. If desired screw holes or holes for nailing can be pre-drilled with a HSS drill Ø 2.5 mm for nails and Ø 3.2 mm for screws.
- With rivets, fixed anchorages are advised to be drilled at Ø 5.2 mm, sliding attachment with Ø 8 x 5.2 mm and moving points Ø 8 mm. Pre-drilling can be done with a HSS drill.
- When fixing ROCKPANEL Lines² 10 mm ROCKPANEL recommends the use of flat headed screws or manual nailing with ring shank nails. When using the 2.1/2.3 x 27 mm ring shank nails pre-drilling to Ø 2 mm is recommended. When using 3.5 x 35 mm stainless steel flat headed screws, pre-drilling to Ø 3.5 mm is recommended and also drilling to countersink the flathead.

Screwing

ROCKPANEL board material and ROCKPANEL Lines² can be fixed mechanically with nails or screws. With a timber sub frame and mechanical fastening with screws, the boards do not have to be pre-drilled before installation. The boards can be mechanically installed on the construction site.



Screw Ø 9.6 mm



Nail Ø 6.0 mm

Nailing

Nailing can be done by hand with a nylon hammer. If application with a pneumatic hammer is required please contact ROCKPANEL Group for advice.

Manual

For the best end result, the ROCKPANEL Group recommends that the boards are pre-drilled at the correct distances with Ø 2.5 mm.

Fixing ROCKPANEL Lines² tongue-and-groove panels

The Lines² 10 mm cladding boards can be mounted in the traditional way, using nails or flat-top screws. However, Lines² 8 mm can also be fixed in a more innovative way, using the new mounting clip. Both methods of installation can be used for both Lines² S and Lines² XL.

Traditional installation Lines² 10

The Lines² 10 mm tongue-and-groove panels can be fixed invisibly using ROCKPANEL ring shank nails or flat-top screws, which results in a traditional tongue-and-groove effect.

Innovative installation Lines² 8

To make the fixing of tongue-and-groove panels easier and 'secret fix', the ROCKPANEL Group has developed an innovative new clip. The clip ensures that the supporting structure is ventilated more effectively, reducing damp retention and thus increasing the structure's durability.

No edge finishing

- Finishing sawn edges from moisture is not needed with ROCKPANEL boards.
- Chamfering is easy using the reverse (non decorative) side of a leftover ROCKPANEL strip to lightly sand the edge.
- If required for aesthetic reasons the side edges can be painted in a corresponding RAL/NCS colour. Without finishing the edges naturally age within several months to a grey-brown colour.

SUB FRAME

Wooden sub frame

Timber stud walls and timber battens fixed to masonry walls should be constructed in accordance with BS EN 1995-1-1:2004 and preservative treated in accordance with EN 335 and BS 8417:2011. Studding and framing should be adequately supported by noggins to ensure rigidity. Where timber stud walls or battens are treated with cuprous preservatives, care must be taken to ensure that sufficient time is allowed for the preservative to properly condition before the cladding is fixed.

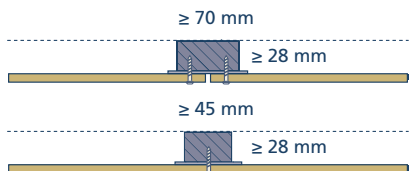

Aluminium sub frame

- The aluminium alloy is AW-6060 according to BS EN 755-2:
 - Rm/Rp0.2 value is 170/140 for profile T6
 - Rm/Rp0.2 value is 195/150 for profile T66
- The minimum thickness of the profile is 1.5 mm.

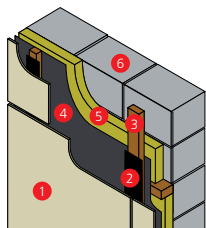

Wooden sub frame

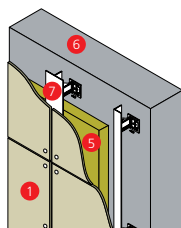

Aluminium sub frame

- 1 ROCKPANEL 8 mm
- 2 EPDM gasket
- 3 Vertical battens
- 4 Breathable membrane
- 5 ROCKWOOL Rainscreen Duoslab
- 6 Inner leaf
- 7 Aluminium profile

Ventilated constructions

It is typical for this kind of facade that the outer facade is constructed as a cavity wall with an inner and an outer layer, resulting in a ventilated space between the facade cladding and the insulation. There are two possibilities: an open or closed construction.

Open construction

Horizontal Joints

With an open construction, the horizontal joints should have a joint of a minimum > 5 mm.

- When using open joints in a **wooden construction**, the structure behind the vertical batten should be protected with a breathable, water repellent and UV resistant membrane. The cavity behind the ROCKPANEL board and between the breathable membrane should be a minimum of 20 mm or greater to say the thickness of the battens in order to drain rainwater. It would be beneficial to have a cavity between 40 mm and 100 mm to make use of pressure equalization and to prevent penetration of excessive rainwater. For those panel systems requiring NHBC approval, a cavity of 35 mm is required.
- With an **aluminium construction** the ROCKPANEL Group recommends a cavity depth between 40 mm and 100 mm. The insulation should comply with the standard BS EN 13162 e.g. ROCKWOOL Rainscreen Duoslab.

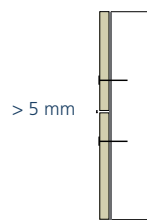

Wooden substructure,
open horizontal joint

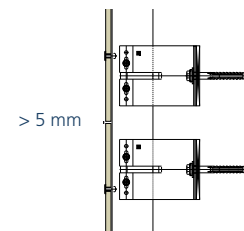

Aluminium substructure,
open horizontal joint

Vertical Joints

The vertical joints are automatically closed by the backing of the vertical substructure. To ensure the durability of the wood, the vertical slats must be well protected against rain water. This can be done with a UV- and weather-resistant EPDM Foamtape that is 15 mm wider on both sides than the framework. It can also be done with a strip of ROCKPANEL material, which acts as gasket to protect the battens.



Wooden substructure,
vertical joint solution

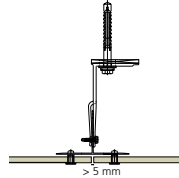

Aluminium substructure,
vertical joint solution

Closed construction

Horizontal Joints

For a closed construction the horizontal joints are closed with a profile, usually a chair or nose profile (semi-closed). Thus the rainwater is drained off as much as possible on the outer side of the cladding. The supporting structure must be ventilated. For example retaining a 20 mm cavity width behind the cladding and 5 mm continuous opening (or equivalent slots) at top and bottom. Further ventilation must be provided in vertical runs exceeding 20 mm. For those panel systems requiring NHBC approval, a continuous opening at the top and bottom is required.

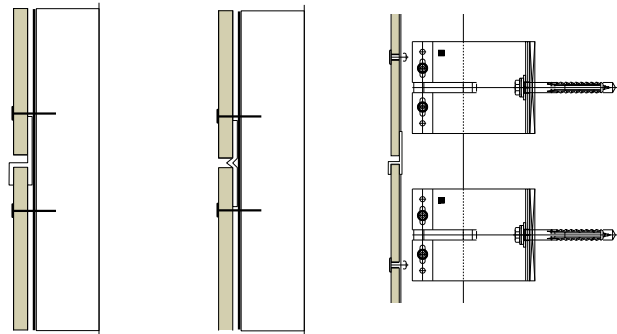

Wooden substructure with closed (left)
and semi-closed (right) horizontal joint

Aluminium substructure
with closed horizontal joint

Vertical joints

The vertical joints are automatically closed by the backing of the vertical substructure. To ensure the durability of the wood, the vertical slats must be well protected against rain water. This can be done with a UV- and weather-resistant EPDM Foamtape adhesive. With a closed joint, the joint sealing strip does not need to protrude. It can also be done with a ROCKPANEL strip.



Wooden substructure,
vertical joint solution

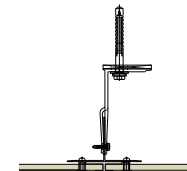

Aluminium substructure,
vertical joint solution

Non-ventilated applications

Thanks to its unique characteristics and the vapour-open structure of ROCKPANEL Rockclad (without ProtectPlus) this product can be used in specific situations in non-ventilated structures. In situations where the preconditions can easily be fulfilled, for example such as infill panels and dormers, the total thickness of the construction is suitable for insulation which leads to a higher U-value.

For non-ventilated applications of ROCKPANEL Rockclad without ProtectPlus the following preconditions are required:

- interior climate with a maximum vapour pressure of 1320 Pa (normal housing and office buildings i.e. no swimming pools or factories);
- the S_d -values of the materials on the inside of the structure down to the insulation should add up to at least 10 m, this value can be achieved with a 0.15 mm thick PE-membrane as vapour barrier and drywall;
- the sum of the S_d -values of the materials on the outside of the structure down to the insulation should add up to less than 2.5 m;
- the inside of the structure should be airtight so that no warm air, containing moisture, can penetrate through the structure;
- the attachments of the boards to the structure should be watertight, so that no rainwater or cleaning water can get behind the cladding. This means that horizontal joints between the ROCKPANEL boards are not allowed. Vertical joints can be applied but should abut at a wooden timber batten covered with a 3 mm x 60 mm soft adhesive EPDM foam gasket;
- only ROCKPANEL Rockclad without ProtectPlus can be used in this application. The S_d -value from ROCKPANEL Rockclad without Protect Plus is 1.8 m.

If you are unsure whether the construction meets these conditions, please contact the ROCKPANEL Group.

JOINTS AND BOARD CONNECTIONS

General

- ROCKPANEL board material is dimensionally stable, and therefore resistant to changes in length and width arising from changes in temperature and humidity. Other materials could expand or contract to varying degrees when compared to ROCKPANEL boards.
- Take into account that boards, installation and building tolerances play an important role in the detailing of joints.
- Apply weather- and UV-resistant joint tape to the seams to protect the substructure against weather influences.
- The joints should be > 5 mm, to ensure proper drainage.
- See paragraph 'ventilated constructions' on page 15 for horizontal and vertical board connections.
- See paragraph 'guidelines ROCKPANEL Lines²' on page 20 for the application of ROCKPANEL Lines².

Guidelines ROCKPANEL Lines²

In horizontal use of ROCKPANEL Lines², horizontal seams are automatically covered by the overlaid board and no additional finishing of the seam is necessary. On vertical framework, weather resistant joint tape should be applied to protect the framework. The ROCKPANEL Group recommends that a joint width of at least 3 mm should be maintained between the boards.

When using the clip to fix Lines² S 8 and Lines² XL 8, protection of the timber battens with weather-resistant joint tape is not recommended. Timber battens should be in accordance with BS EN 1995-1-1:2004 and preservative treated in accordance with EN 335 and BS 8417:2011.

With Lines² 8 mm installed in a demountable fashion, each board can be secured horizontally and vertically. Even when the boards are secured they still can be replaced individually. If horizontal secured fixing is used, automatically a small vertical joint of 3 mm will be applied between the boards.

Corner and edge solutions

Finishing the edges is only necessary to meet any design or aesthetic requirements. The ROCKPANEL Group offers a range of solutions for an attractive finish at corners and edges.

Assembly corner joint with natural grey-brown edges

Without finishing, the basic material changes colour to natural grey-brown under the effect of UV.



Corner profiles in a RAL colour

A solution with a corner profile in a compatible RAL colour ensures a perfect finish.

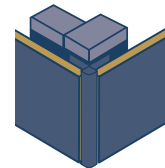

See pages 49 and 50 for a complete overview of the profiles.

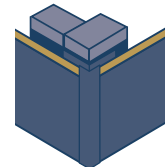

Mitre joint

For the highly skilled installer, a mitre joint can be made with the material, thereby creating a precise and uniform finish.

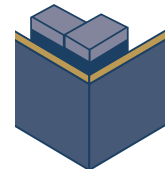

Important: the minimum panel thickness for this solution is 8 mm.

Edge paint

Finishing the edges with matching colour paint is another option.

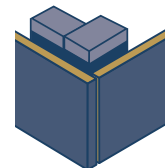

Bending and curving

ROCKPANEL board material can easily be curved on the building site if required. The following values only apply for the Durable grade. Please contact the ROCKPANEL Group for the other grades e.g. FS-Xtra.

ROCKPANEL Rockclad, Woods, Metallics, Brilliant, Chameleon		
Panel thickness (mm)	6	8
Panel dimensions (Curve, mm)	3050	3050
Radius R minimal (mm)	1900	2500
Angle α	91.97°	69.9°
Chord (mm)	2733	2864
Level (mm)	580	451
Common ground c.t.c. (mm)	300	400
Fixingdistance c.t.c. (mm)*	250	300

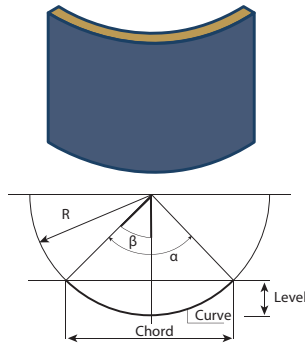

* For urban and rural environments. In case you want to install curved boards at buildings higher than 10 meter or at buildings in areas with higher wind load, please contact the ROCKPANEL Group.

FIXING

The ROCKPANEL Group offers a broad range of fixings; nails, screws as well as a fire safe adhesive system developed in collaboration with Bostik. All are suitable and thoroughly tested to be applied in combination with our board material.

In case you want to use other fixings different than ROCKPANEL original fixings please ensure with the supplier the suitability of their fixings to meet our technical requirements. Always check that accessories are suitable for the design and its associated performance requirements. It is further recommended to use only coloured fixings with a durable finish. Working with accessories from other manufacturers should be carried out according to their recommendations, their supervision and their warranty conditions.

Mechanical fixing on wood

- ROCKPANEL ring shank nails (stainless steel material number 1.4401 or 1.4578) 2,7/2,9 x 32 mm (flat-top).
- ROCKPANEL ring shank nails (stainless steel material number 1.4401 or 1.4578) 2.1/2.3 x 27 mm (flat-top) for fixing ROCKPANEL Lines² 10 mm.
- Stainless steel flat-top screws of 3.5 x 30 mm with a head diameter of \varnothing 6.6 mm for fixing ROCKPANEL Lines² 10 mm. The tongue should be predrilled with a steel drill \varnothing 3.5 mm and the hole for the flat-top screw head should be sunk with a countersink bore. The top of the screw head should be level with the surface of the tongue. Tension in the mounting of the tongue can be avoided by tightening to an appropriate level and by ensuring they are driven in to the batten in a true fashion.
- ROCKPANEL Torx screws (stainless steel material number 1.4401 or 1.4578) 4,5 x 35 mm. Nail heads in the same RAL colour combine perfectly with the RAL colour of the board material.

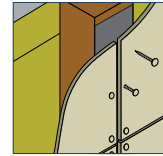

Ring shank nails

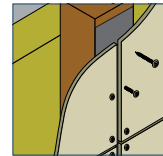

Torx screws

Mechanical fixing on aluminium

For the mounting of ROCKPANEL board material on aluminium load-bearing sections, \varnothing 14 mm AP14-50180-S flat-topped aluminium pop rivets can be used:

- material EN-AW-5019 in conformity with EN 755-2. Mandrel material number 1.4541 in conformity with EN 10088.

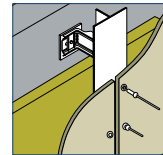

Mechanical fixing on aluminium

When installing ROCKPANEL boards on aluminium load-bearing sections, fixed points, slotted holes and moving points should be applied. By applications of fixed points and moving points the fixed points should be pre-drilled with \varnothing 5.2 mm, slotted points \varnothing 5,2 x 8 mm and the moving points with \varnothing 8 mm. The sliding attachment must be done with a 'rivet spacer' so that the attachment can move easily. Instead of drilling fix points and slotted holes also fix-point sleeves and side sleeves can be used to achieve the required holes. Contact the ROCKPANEL group for more information.

Adhesive installation

In collaboration with Bostik, the ROCKPANEL Group has developed a fire safe European-certified adhesive system compatible with the European standards of ROCKPANEL board material. If you prefer to use another adhesive system, always verify that the chosen system meets the requirements for application with ROCKPANEL board material. If using another adhesive system, the adhesive supplier becomes responsible for technical approvals and guarantee.

Note: The quality of the adhesive bonding is partly determined by the weather conditions during application. For more information refer to the adhesive supplier.

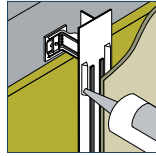

Adhesive installation

Easy Fix; for a ship lap construction

The ROCKPANEL Group has developed a secret fixing system for cladding boards in 8 mm using a mounting spacer called ROCKPANEL Easy Fix. The Easy Fix clips onto the boards to allow a simple and stress free assembly, which presets the position of the fixing screws. For more information about assembly see processing and the product data sheet on www.rockpanel.co.uk.

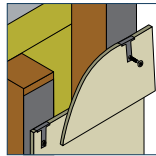

Easy Fix



ROCKPANEL board sizes	
Gross width (b)	Effective width (b _w)
285 - 340 mm	b - 60 mm

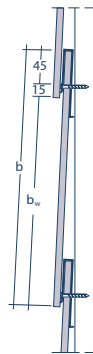

Fixing ROCKPANEL Lines²

ROCKPANEL Lines² are tongue-and-groove cladding boards suitable for horizontal application in ventilated constructions. The panels are available in a small (S) and an extra wide (XL) version. The thicknesses available are 8 and 10 mm each of which has a different fixing method.

ROCKPANEL Lines² 8 tongue-and-groove panels (with clip)

With the innovative clip developed by the ROCKPANEL Group, you can choose between a fixed and demountable installation of Lines² S 8 and Lines² XL 8 tongue-and-groove panels. For demountable installation, the tongue-and-groove board is simply inserted into the clip so that each panel can be removed separately.



Mounting clip

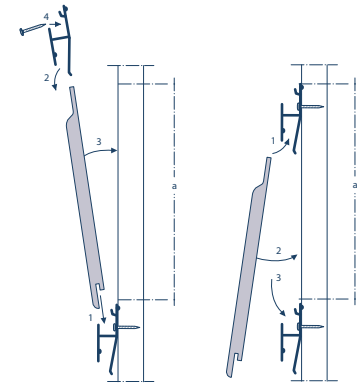

Fixed

(Secured)
Demountable



Narrow groove in the case of fixed installation



Wide groove in the case of demountable installation

Lines² S 8

Lines² XL 8

Clip spacing (a)		
Type	Fixed	(Secured) Demountable
ROCKPANEL Lines ² S 8	151 mm	156 mm
ROCKPANEL Lines ² XL 8	282 mm	287 mm

Mounting of Lines² S 8 and Lines² XL 8 is either with a fixed or demountable attachment, depending on the clip spacing used. Variations of this can be achieved with the working sheet width of 151-156 mm for Lines² S 8 and of 282-287 mm for Lines² XL 8.

ROCKPANEL Lines² 10 tongue-and-groove panels

The Lines² 10 tongue-and-groove panels can be fixed invisibly by means of ROCKPANEL ring shank nails or flat-top screws, which results in a traditional tongue-and-groove effect.

Type	Panel width	Working panel width
ROCKPANEL Lines ² S 10	164 mm	146 mm
ROCKPANEL Lines ² XL 10	295 mm	277 mm

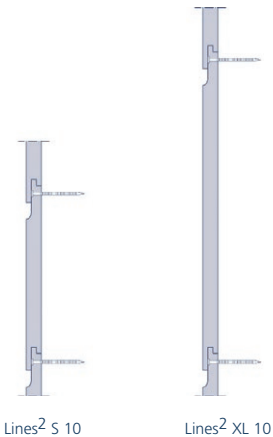

DISTANCES BETWEEN FASTENING POINTS

In the chapter “Distances between fastening points” the maximum approved fixing distances for flat boards of Durable grade fixed to a wooden or aluminium substructure are defined. However the fixing distances can differ for each project as the fixing distance has to be calculated in accordance with the actual situation (i.e. building height, wind speed etc.).

Distances between fastening points in accordance with ETA approval

The table below shows the maximum fixing distances at a vertical timber substructure or aluminium substructure in accordance with ETA-07/0141 and ETA-08/0343.

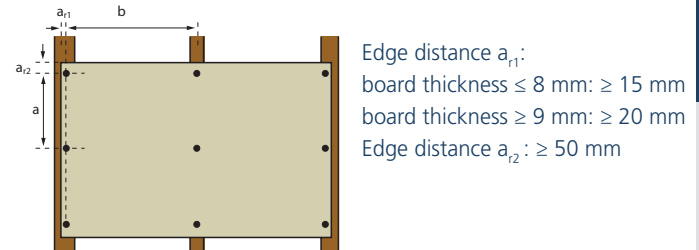

Maximum fixing distances according approval				
	ROCKPANEL Durable 6 mm*		ROCKPANEL Durable 8 mm*	
Fastening system	Maximum Span (b)	Maximum distance between Fasteners (a)	Maximum Span (b)	Maximum distance between Fasteners (a)
Screw	400 mm	300 mm	600 mm	600 mm
Ring shank nail	480 mm	300 mm	600 mm	400 mm
Rivet	-	-	600 mm	600 mm
Bonding system	The maximum span between the bonding strips at an 8 mm board will be 600 mm (b)*.			

* Maximum distances are not applicable for ROCKPANEL Natural and ROCKPANEL Ply.

Determining the fixing distances

When determining the fixing distances the following variables should be taken into account:

- Wind load
 - Determine the fundamental local basic wind velocity;
 - Determine the maximum height of the building;
 - Determine the site altitude;
 - Determine the distance from the coast;
 - Determine the distance to the town border.
- Building area: zone A (corner area) or zone B (area between corners). For details see the figure below.

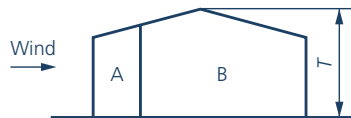

A = Corner area
 B = Area between the corners
 T = Total building height

- Type of board, thickness and fastening system
- Static load absorption, for example 1-field- or 2-field span
- Legal local requirements

Calculation examples: fixing distances and maximum permissible building heights

The calculation examples on page 30-33 are based on the properties of ROCKPANEL Durable. The tables show the distances between fastening points (mm) in relation to the basic wind velocity and the location in the country. The calculation examples on page 34-35 show the maximum permissible building heights (m) for which ROCKPANEL Lines² can be used in relation to the basic wind velocity.

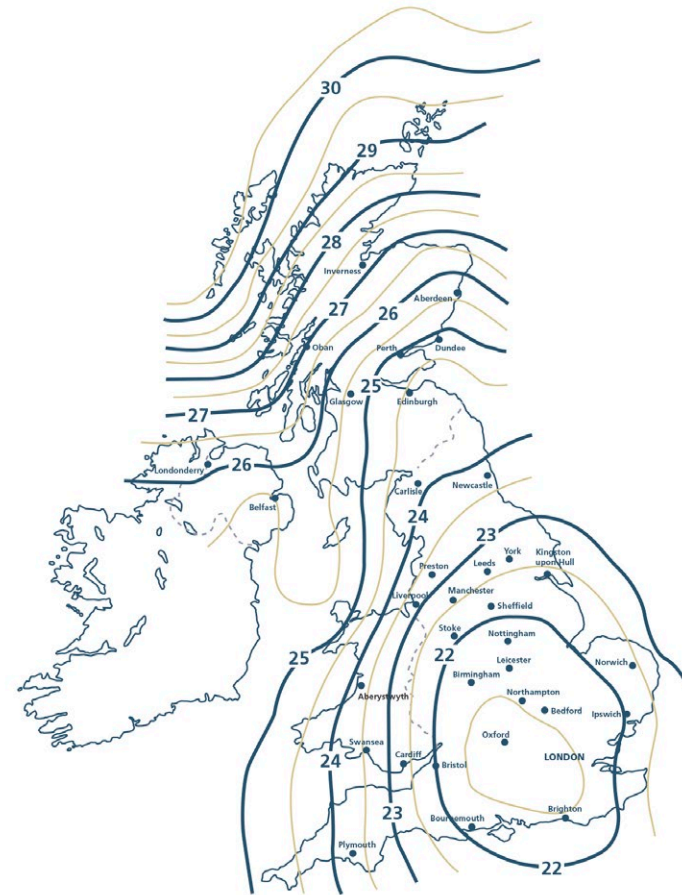

- This map is an indication of the fundamental basic wind velocity according to BE-EN 1991-1-4. If you are unsure which zone the building is in, please contact the ROCKPANEL Group.

Calculation examples: Fixing distances

Fixing distances (mm) for ROCKPANEL Rockclad / Woods / Metallics / Brilliant / Chameleon in Durable grade

- Location in country
- Distance from coast > 10 km
- Site altitude ≤ 50 m
- Building height ≤ 10 m
- Strength class timber: c24 according EN338
- Aluminium according approval
- $a_{r1} \geq 15$ mm
- $a_{r2} \geq 50$ mm

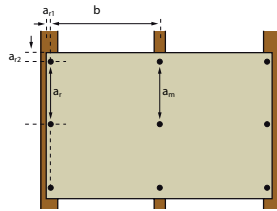

8 mm panels

Wind speed		22 m/s	23 m/s	24 m/s	25 m/s	26 m/s
	b	$a_m(a_r)$	$a_m(a_r)$	$a_m(a_r)$	$a_m(a_r)$	$a_m(a_r)$
Torx-screw	600	330 (500)	-	-	-	-
	500	400 (600)	365 (550)	335 (505)	310 (465)	285 (430)
	400	500 (600)	455 (580)	420 (565)	385 (550)	355 (535)
Rivet onto Aluminium	600	405 (600)	-	-	-	-
	500	490 (600)	445 (580)	410 (565)	380 (550)	350 (535)
	400	600 (600)	560 (580)	515 (565)	475 (550)	435 (535)

6 mm panels

Torx-screw	400	300 (300)	285 (300)	260 (300)	240 (300)	255 (300)
	300	300 (300)	300 (300)	300 (300)	300 (300)	220 (300)

- If the table shows no fixing distance (-), contact the ROCKPANEL Group for the possibilities and specific advice.
- For applications < 10 km from the coast, also at higher site altitudes and higher wind speeds, the ROCKPANEL Group should be consulted.
- For buildings with a height > 10 m, also for buildings with a non-conventional shape the ROCKPANEL Group should be consulted.
- The specification of the ROCKPANEL screw and rivet should be in accordance with the appropriate ETA.

Fixing distances (mm) for ROCKPANEL Rockclad / Woods / Metallics / Brilliant / Chameleon in Durable grade

- Location in country
- Distance from coast > 10 km
- Site altitude ≤ 50 m
- Building height ≤ 10 m
- Strength class timber: c24 according EN338
- Aluminium according approval
- $a_{r1} \geq 15$ mm
- $a_{r2} \geq 50$ mm

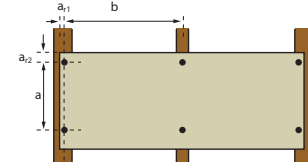

8 mm panels

Wind speed		22 m/s	23 m/s	24 m/s	25 m/s	26 m/s
	b	a	a	a	a	a
Torx-screw	600	275	-	-	-	-
	500	350	310	280	250	220
	400	440	415	375	335	305
Rivet onto Aluminium	600	380	-	-	-	-
	500	440	425	385	345	315
	400	440	425	415	400	395

6 mm panels

Torx-screw	400	300	285	255	230	205
	300	300	300	300	300	290

- If the table shows no fixing distance (-), contact the ROCKPANEL Group for the possibilities and specific advice.
- For applications < 10 km from the coast, also at higher site altitudes and higher wind speeds, the ROCKPANEL Group should be consulted.
- For buildings with a height > 10 m, also for buildings with a non-conventional shape the ROCKPANEL Group should be consulted.
- The specification of the ROCKPANEL screw and rivet should be in accordance with the appropriate ETA.

Fixing distances (mm) for ROCKPANEL Rockclad / Woods / Metallics / Brilliant / Chameleon in Durable grade

- Location in country
- Distance from coast > 10 km
- Site altitude ≤ 50 m
- Building height ≤ 10 m
- Strength class timber: c24 according EN338
- Aluminium according approval
- $a_{r1} \geq 15$ mm
- $a_{r2} \geq 50$ mm

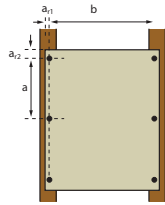
8 mm panels

Wind speed		22 m/s	23 m/s	24 m/s	25 m/s	26 m/s
	b	a	a	a	a	a
Torx-screw	600	-	-	-	-	-
	500	-	-	-	-	-
	400	565	515	475	435	-
Rivet onto Aluminium	600	-	-	-	-	-
	500	-	-	-	-	-
	400	600	580	565	550	-

6 mm panels

Torx-screw	400	-	-	-	-	-
	300	300	300	300	300	-

- If the table shows no fixing distance (-), contact the ROCKPANEL Group for the possibilities and specific advice.
- For applications < 10 km from the coast, also at higher site altitudes and higher wind speeds, the ROCKPANEL Group should be consulted.
- For buildings with a height > 10 m, also for buildings with a non-conventional shape the ROCKPANEL Group should be consulted.
- The specification of the ROCKPANEL screw and rivet should be in accordance with the appropriate ETA.

Fixing distances (mm) for ROCKPANEL Rockclad / Woods / Metallics / Brilliant / Chameleon in Durable grade

- Location in country
- Distance from coast > 10 km
- Site altitude ≤ 50 m
- Building height ≤ 10 m
- Strength class timber: c24 according EN338
- Aluminium according approval
- $a_{r1} \geq 15$ mm
- $a_{r2} \geq 50$ mm

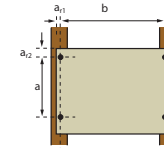
8 mm panels

Wind speed		22 m/s	23 m/s	24 m/s	25 m/s	26 m/s
	b	a	a	a	a	a
Torx-screw	600	-	-	-	-	-
	500	-	-	-	-	-
	400	440	425	415	400	-
Rivet onto Aluminium	600	-	-	-	-	-
	500	-	-	-	-	-
	400	440	425	415	400	-

6 mm panels

Torx-screw	400	-	-	-	-	-
	300	300	300	300	300	-

- If the table shows no fixing distance (-), contact the ROCKPANEL Group for the possibilities and specific advice.
- For applications < 10 km from the coast, also at higher site altitudes and higher wind speeds, the ROCKPANEL Group should be consulted.
- For buildings with a height > 10 m, also for buildings with a non-conventional shape the ROCKPANEL Group should be consulted.
- The specification of the ROCKPANEL screw and rivet should be in accordance with the appropriate ETA.

Fixing distances ROCKPANEL Lines²

<ul style="list-style-type: none"> - Location in country - Distance from coast > 10 km - Site altitude ≤ 50 m - Strength class timber: c24 according EN338 - Cavity closers at the corners - $a_{r1} \geq 15$ mm - $a_{r2} = 15$ mm 	
---	--

Maximum permissible building height (m) Lines² 8 mm with a 2-field span or more than 2 fields, fixed using a single ROCKPANEL clip at the intermediate battens. Clips and screws for fixing are supplied by the ROCKPANEL Group.

Wind speed	Span c.t.c. (mm)	Lines ² 8 XL		Lines ² 8 S	
		Zone B: Middle area	Zone A: Corner area	Zone B: Middle area	Zone A: Corner area
22 m/s	500	30*	-	30*	30*
	400	30*	7	30*	30*
23 m/s	500	20*	-	30*	20
	400	30*	5	30*	30*
24 m/s	500	15	-	30*	20
	400	30*	-	30*	30*
25 m/s	500	15	-	30*	15
	400	30	-	30*	30
26 m/s	500	10	-	30	10
	400	20	-	30*	20

See explanation above
- $a_{r3} \geq 20$ mm

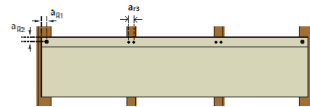

Maximum permissible building height (m) Lines² 8 mm with a 2-field span or more than 2 fields, fixed using a double ROCKPANEL clip at the intermediate battens. Clips and screws for fixing are supplied by the ROCKPANEL Group.

Wind speed	Span c.t.c. (mm)	Lines ² 8 XL		Lines ² 8 S	
		Zone B: Middle area	Zone A: Corner area	Zone B: Middle area	Zone A: Corner area
22 m/s	500	30*	20	30*	30*
	400	30*	30*	30*	30*
23 m/s	500	30*	15	30*	30*
	400	30*	30	30*	30*
24 m/s	500	30*	10	30*	30*
	400	30*	20	30*	30*
25 m/s	500	30*	7	30*	30*
	400	30*	15	30*	30*
26 m/s	500	30	5	30	30
	400	30*	10	30*	30*

- If the table shows no fixing distance (-), contact the ROCKPANEL Group for the possibilities and specific advice.
- For applications < 10 km from the coast, also at higher site altitudes or higher wind speeds, the ROCKPANEL Group should be consulted.
- For buildings with a non-conventional shape the ROCKPANEL Group should be consulted.
- Specification of the fasteners should be in accordance with the appropriate ETA.

* Higher buildings not calculated. Contact the ROCKPANEL Group for advice.

<ul style="list-style-type: none"> - Location in country - Distance from coast > 10 km - Site altitude ≤ 50 m - Strength class timber: c24 according EN338 - Cavity closers at the corners - $a_{r1} \geq 15$ mm - $a_{r2} = 15$ mm 	
---	--

Maximum permissible building height (m) Lines² 10 mm with a 2-field span or more than 2 fields, fixed using a single ROCKPANEL ring shank nail 2,1/2,3 x 27 mm at the intermediate battens.

Wind speed	Span c.t.c. (mm)	Lines ² 10 XL		Lines ² 10 S	
		Zone B: Middle area	Zone A: Corner area	Zone B: Middle area	Zone A: Corner area
22 m/s	600	-	-	30	10
	500	5	-	30*	20
23 m/s	600	-	-	20	7
	500	-	-	30*	15
24 m/s	600	-	-	15	5
	500	-	-	30	10
25 m/s	600	-	-	10	-
	500	-	-	20	7
26 m/s	600	-	-	7	-
	500	-	-	15	5

See explanation above
- $a_{r3} \geq 20$ mm

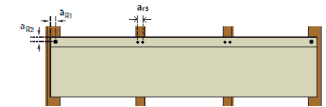

Maximum permissible building height (m) Lines² 10 mm with a 2-field span or more than 2 fields, fixed using a double ROCKPANEL ring shank nail 2,1/2,3 x 27 mm at the intermediate battens.

Wind speed	Span c.t.c. (mm)	Lines ² 10 XL		Lines ² 10 S	
		Zone B: Middle area	Zone A: Corner area	Zone B: Middle area	Zone A: Corner area
22 m/s	600	30	10	30*	30*
	500	30*	20	30*	30*
23 m/s	600	20	7	30*	30
	500	30*	15	30*	30*
24 m/s	600	15	7	30*	20
	500	30	15	30*	30*
25 m/s	600	10	5	30*	15
	500	20	10	30*	30*
26 m/s	600	7	-	30	10
	500	15	7	30*	30*

- If the table shows no fixing distance (-), contact the ROCKPANEL Group for the possibilities and specific advice.
- For applications < 10 km from the coast, also at higher site altitudes or higher wind speeds, the ROCKPANEL Group should be consulted.
- For buildings with a non-conventional shape the ROCKPANEL Group should be consulted.
- Specification of the fasteners should be in accordance with the appropriate ETA.

* Higher buildings not calculated. Contact the ROCKPANEL Group for advice.

Fixing of other ROCKPANEL products

For the fixing guidelines applicable to other ROCKPANEL products, please consult the technical product datasheets at www.rockpanel.co.uk.

Adhesive installation

Adhesive installation of ROCKPANEL board material should be carried out according to the instructions of the adhesive system manufacturer and under the manufacturer's supervision and warranty conditions. In collaboration with the ROCKPANEL Group, Bostik has developed the ROCKPANEL Tack-S system (ETA 07/0141). For more information see the product data sheet on www.rockpanel.co.uk or consult the ETA 07/0141.

Horizontal applications

If ROCKPANEL board material is used horizontally, for example in a ceiling application, the specific weight of the board must be taken into account in the calculation of the fixing distances. As a rule of thumb, the fixing distances can be multiplied by 0.75.

MAINTENANCE

Cleaning

The advice of the ROCKPANEL Group is to clean the board material once per year with water. If desired, the board material can be cleaned with, for example, a car shampoo or an all-purpose cleaner, diluted as indicated by the manufacturer. This solution prevents contamination by dirt so that the colour is preserved for a long time.

Extra protection: ProtectPlus

ROCKPANEL Rockclad can be optionally finished with a ProtectPlus layer. ROCKPANEL Woods / Chameleon / Metallics / Brilliant (with the exception of Aluminium White and Aluminium Grey) have a standard ProtectPlus finish. Due to the tightly closed surface of the ProtectPlus layer, it is almost impossible for dirt to attach itself. The strength of the ProtectPlus layer means that the surface of the boards can remain dirt free for years to come. The layer does not lose its effectiveness over time, and is therefore one of the best self-cleaning cladding surfaces on the market. ProtectPlus has an integrated UV blocker and ensures excellent colour fastness. Graffiti is easy to remove with ROCKPANEL Graffiti Cleaner.

Repainting

ROCKPANEL Rockclad and ROCKPANEL Lines² are finished with a water-based coating system which makes it easy to repaint if desired for aesthetic reasons. For advice on repainting, the ROCKPANEL Group recommends contacting the paint supplier direct. Note that it is not possible to repaint ROCKPANEL board material that has a ProtectPlus finish (this applies to ROCKPANEL Rockclad (with ProtectPlus), ROCKPANEL Woods, ROCKPANEL Metallics, ROCKPANEL Brilliant and ROCKPANEL Chameleon).

Attention: If ROCKPANEL board material is repainted, properties related to its coating may change. In this instance, you should fully consider colour, surface structure and the vapour-permeable properties of the ROCKPANEL board. If you wish to repaint ROCKPANEL Rockclad in an unventilated application, it is important that you consider and evaluate with the paint supplier the moisture-regulating properties of the new paint to be applied.

DETAILING

FACADE

1-200 | Mechanically fixed on timber support,

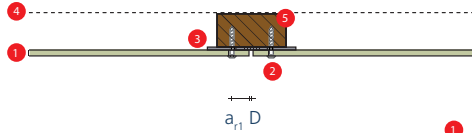

- 1 ROCKPANEL 6 or 8 mm
- 2 ROCKPANEL ring shank nail or ROCKPANEL screw
- 3 EPDM gasket
- 4 Breathable membrane
- 5 Battens 28 x 70 mm
- D Assembly joint
- a_{11} 15 mm edge distance

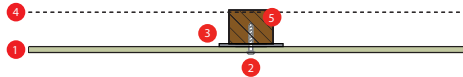

- 1 ROCKPANEL 6 or 8 mm
- 2 ROCKPANEL ring shank nail or ROCKPANEL screw
- 3 EPDM gasket
- 4 Breathable membrane
- 5 Battens 28 x 45 mm

1-201 | Mechanically fixed to timber supports, internal and external corner

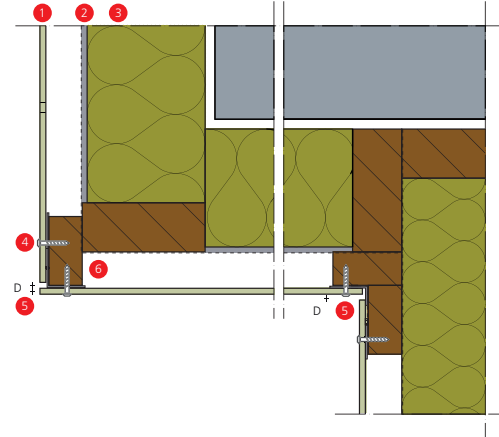

- 1 ROCKPANEL 6 or 8 mm
- 2 Breathable membrane
- 3 Insulation (e.g. ROCKWOOL Rainscreen Duoslab)
- 4 ROCKPANEL ring shank nail or ROCKPANEL screw
- 5 EPDM gasket
- 6 Battens 28 x 70 mm
- D Assembly joint

1-208 | Mechanically fixed to timber supports, with external corner profile.

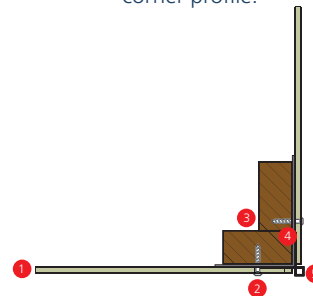

- 1 ROCKPANEL 6 or 8 mm
- 2 ROCKPANEL ring shank nail or ROCKPANEL screw
- 3 Battens 28 x 70 mm
- 4 EPDM gasket
- 5 ROCKPANEL corner profile type D

2-200B | Mechanically fixed to aluminium supports, abutment vertical joint

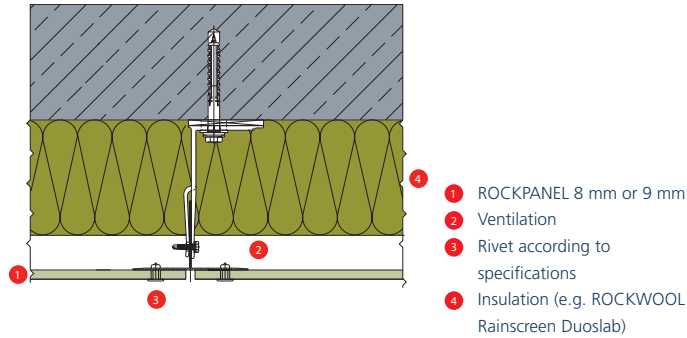

Important: For aluminium constructions in an open facade the ROCKPANEL Group recommends a cavity depth between 40 mm and 100 mm.

2-201B | Mechanically fixed to aluminium supports, external corner

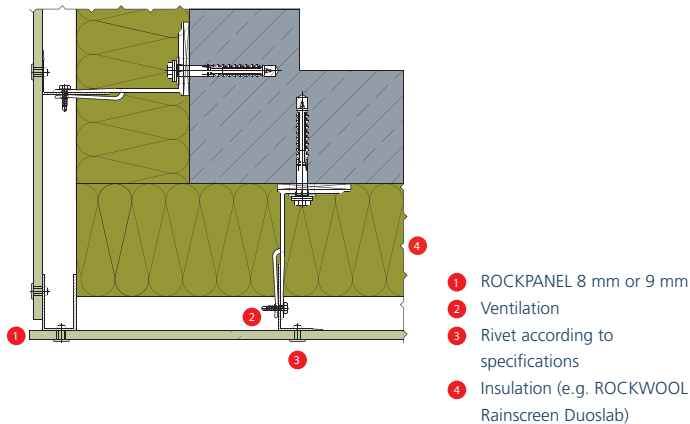

ROOFLINE

1-501 | Mechanically fixed to timber supports, fascia board new build

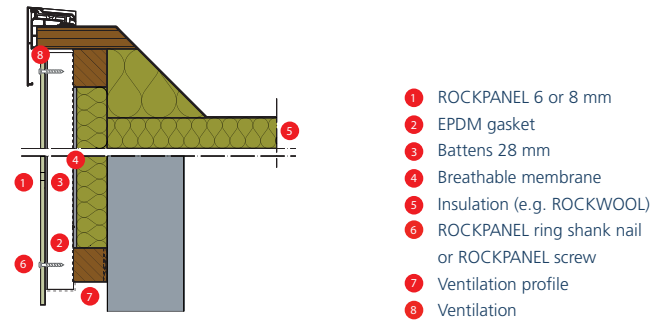

1-504B | Mechanically fixed to timber supports, fascia board renovation

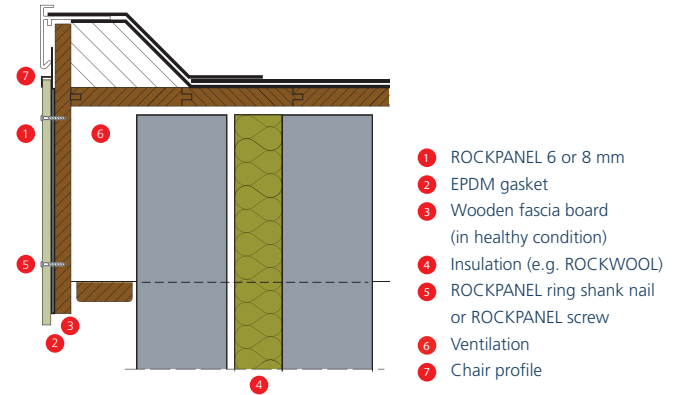

Attention: An EPDM gasket should be provided to ensure watertight connections at the point where the ROCKPANEL sheet is fixed over the existing sub frame.

1-509 | Mechanically fixed to timber supports, soffit board new build

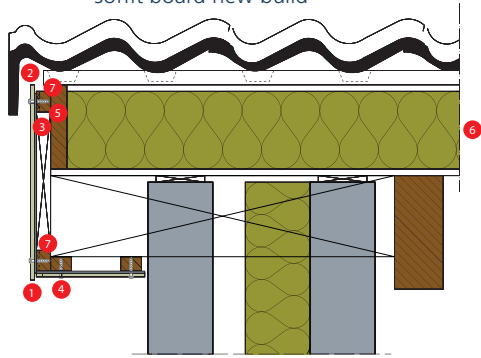

- 1 ROCKPANEL 6 or 8 mm
- 2 Ventilation
- 3 EPDM gasket
- 4 ROCKPANEL ring shank nail or ROCKPANEL screw
- 5 Battens
- 6 Insulation (e.g. ROCKWOOL)
- 7 Ventilation gap in horizontal battens

1-511 | Mechanically fixed to timber supports, soffit board renovation

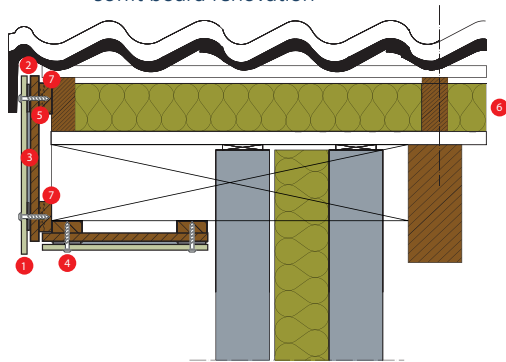

- 1 ROCKPANEL 6 or 8 mm
- 2 Ventilation
- 3 EPDM gasket
- 4 ROCKPANEL ring shank nail or ROCKPANEL screw
- 5 Existing multi-ply cladding (in healthy condition)
- 6 Insulation (e.g. ROCKWOOL)
- 7 Ventilation gap in horizontal battens

DETAILING

1-350 | Mechanically fixed to timber supports, junction at window-sill

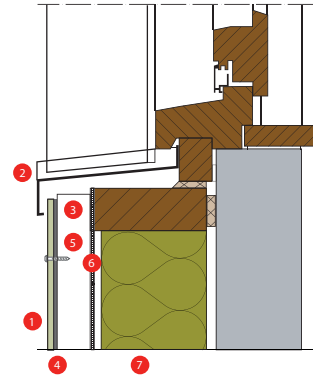

- 1 ROCKPANEL 8 mm
- 2 Aluminium window-sill with bulkhead
- 3 Ventilation
- 4 EPDM gasket
- 5 Battens
- 6 Breathable membrane
- 7 Insulation (e.g. ROCKWOOL)

1-351 | Mechanically fixed to timber supports, junction at window head

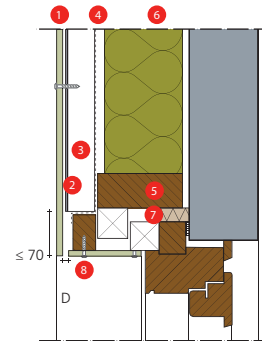

- 1 ROCKPANEL 8 mm
- 2 EPDM gasket
- 3 Battens
- 4 Breathable membrane
- 5 Framework
- 6 Insulation (e.g. ROCKWOOL)
- 7 PU foam
- 8 ROCKPANEL ring shank nail or ROCKPANEL screw
- D Assembly joint

1-552 | Mechanically fixed to timber supports, connection at ground level

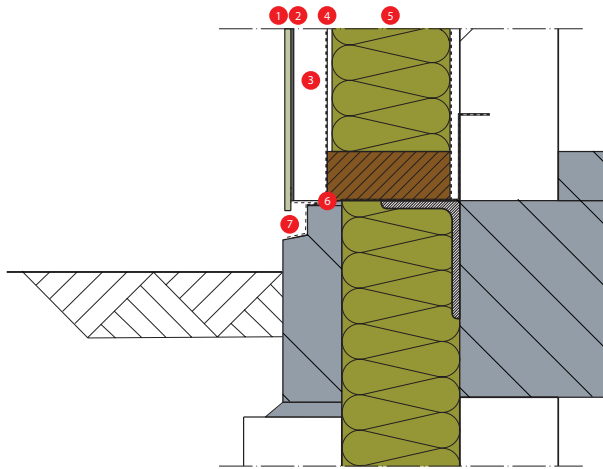

- 1 ROCKPANEL 8 mm
- 2 EPDM gasket
- 3 Battens / ventilation
- 4 Breathable membrane
- 5 Insulation (e.g. ROCKWOOL)
- 6 Lead flashing / cavity tray
- 7 Access for ventilation

2-275 | Mechanical fixing - ETICS

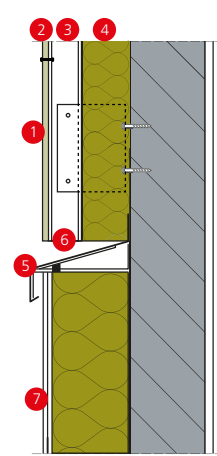

- 1 ROCKPANEL \geq 8 mm
- 2 EPDM gasket
- 3 Rail support / ventilation
- 4 Insulation (e.g. ROCKWOOL)
- 5 Flashing
- 6 Ventilation
- 7 ETICS system according to external manufacturer

2-276 | Mechanical fixing - ETICS

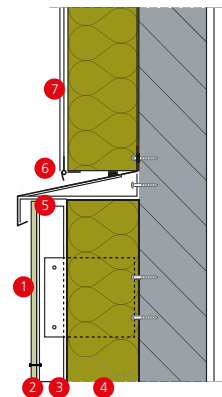

- 1 ROCKPANEL \geq 8 mm
- 2 EPDM gasket
- 3 Rail support / ventilation
- 4 Insulation (e.g. ROCKWOOL)
- 5 Insect mesh
- 6 Flashing
- 7 ETICS system according to external manufacturer

NON-VENTILATED APPLICATIONS

1-400 | Mechanically fixed to timber support, non-ventilated infilling (horizontal)

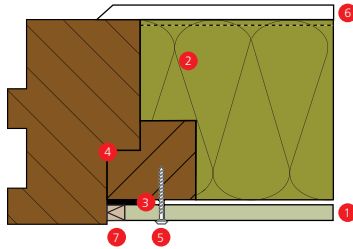

- 1 ROCKPANEL Rockclad (without ProtectPlus) 6 or 8 mm
 - 2 Insulation (e.g. ROCKWOOL)
 - 3 Non-sticking layer, for example PE-foil
 - 4 Battens
 - 5 ROCKPANEL screw
 - 6 Vapour barrier $S_d > 10$ m
 - 7 Sustainable elastic sealant
- See also preconditions on page 18

1-450 | Mechanically fixed to timber support, non-ventilated infilling (vertical)

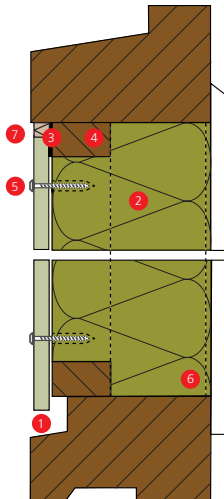

- 1 ROCKPANEL Rockclad (without ProtectPlus) 6 or 8 mm
 - 2 Insulation (e.g. ROCKWOOL)
 - 3 Non-sticking layer, for example PE-foil
 - 4 Battens
 - 5 ROCKPANEL screw
 - 6 Vapour barrier $S_d > 10$ m
 - 7 Sustainable elastic sealant
- See also preconditions on page 18

STANDARD RANGE AND AVAILABILITY

BOARDS

	Dimensions*	Availability
ROCKPANEL Rockclad	Panel thickness: 6 mm and 8 mm Panel width: 1200 mm and 1250 mm Panel length: 2500 mm and 3050 mm	20 standard colours in stock. Orders > 100 m ² maximum 6 weeks.
ROCKPANEL Rockclad Bright	Panel thickness: 8 mm Panel width: 1200 mm Panel length: 3050 mm	4 standard colours in stock. Orders > 100 m ² maximum 6 weeks.
ROCKPANEL Ply Light grey primer	Panel thickness: 6 mm, 8 mm and 10 mm Panel width: 1200 mm and 1250 mm Panel length: 2500 mm and 3050 mm	A stock item. Orders > 100 m ² maximum 6 weeks.
ROCKPANEL Lines ²	Panel thickness: 8 mm and 10 mm Panel width**: 164 mm and 295 mm Panel length: 3050 mm	A stock item. Orders > 100 m ² maximum 6 weeks.
ROCKPANEL Woods***	Panel thickness: 8 mm Panel width: 1200 mm and 1250 mm Panel length: 3050 mm	A stock item. Orders > 100 m ² maximum 6 weeks.
ROCKPANEL Natural	Panel thickness: 8 mm and 10 mm Panel width: 1200 mm and 1250 mm Panel length: 2500 mm and 3050 mm	A stock item. Orders > 100 m ² maximum 6 weeks.
ROCKPANEL Chameleon***	Panel thickness: 8 mm Panel width: 1200 mm and 1250 mm Panel length: 3050 mm	A stock item. Orders > 100 m ² maximum 6 weeks.
ROCKPANEL Metallics***	Panel thickness: 8 mm Panel width: 1200 mm and 1250 mm Panel length: 3050 mm	A stock item. Orders > 100 m ² maximum 6 weeks.
ROCKPANEL Brilliant***	Panel thickness: 8 mm Panel width: 1200 mm and 1250 mm Panel length: 3050 mm	Available from 100 m ² maximum 6 weeks.

* Panel width 1250 mm is available from 100 m² with a maximum delivery time of 6 weeks.

** Working sheet width Lines² 10: respectively 146 mm and 277 mm.
Working sheet width Lines² 8: respectively 151-156 mm and 282-287 mm.

*** The required amount of this ROCKPANEL product for a certain project should be ordered as one batch to avoid any slight variation between batches.

Colour customisation

Besides the standard range of ROCKPANEL Rockclad the ROCKPANEL Group is also able to produce any RAL or NCS colour. Contact the ROCKPANEL Group for the possibilities and delivery times.

Width customisation

ROCKPANEL Group offers the possibility to supply custom made boards. Length can be adjusted to your project requirements. Standard board tolerances as mentioned in the Product Data Sheets also apply to the custom made boards. As a result of the innovative production process of the board material, the board can now be delivered in all lengths between 1700 mm and 3050 mm and in width 1200 mm or 1250 mm.

Minimum order: 300 m² per format/colour.
Delivery time: maximum 6 weeks.

Extra protection: ProtectPlus











ROCKPANEL Rockclad can be treated with a ProtectPlus finish as an option. ROCKPANEL Woods / Chameleon / Metallics / Brilliant come with the ProtectPlus finish as standard. With the exception of ROCKPANEL Metallics Aluminium White and Aluminium Grey.

ROCKPANEL Rockclad ProtectPlus*:
Minimum order: 100 m² (per Colour)
Delivery time: maximum 6 weeks

* We do not advice mixing ROCKPANEL Rockclad with and without ProtectPlus on the same facade.

ACCESSORIES





ROCKPANEL Profiles

Standard length is 3055 mm		Colour*	Panel thickness**	Availability
Profile A		Blanc adonised 20 Standard/ 4 Bright Special/ Custom	6, 8, 10 mm	1 week 4 weeks 6 weeks
Profile B		Blanc adonised RAL 9005/ RAL 9010	One size fits all	1 week 1 week
Profile C		Blanc adonised 20 Standard/ 4 Bright Special/ Custom	6, 8, 10 mm	1 week 4 weeks 6 weeks
Profile D		Blanc adonised 20 Standard/ 4 Bright Special/ Custom	6, 8, 10 mm	1 week 4 weeks 6 weeks
Profile E		Blanc adonised 20 Standard/ 4 Bright Special/ Custom	6, 8, 10 mm	1 week 4 weeks 6 weeks
Profile F		Blanc adonised 20 Standard/ 4 Bright Special/ Custom	6, 8, 10 mm	1 week 4 weeks 6 weeks
Profile G (Easy Fix assembly)		Blanc adonised 20 Standard/ 4 Bright Special/ Custom	8 mm	1 week 4 weeks 6 weeks
Profile H		Blanc adonised 20 Standard/ 4 Bright Special/ Custom	6, 8, 10 mm	1 week 4 weeks 6 weeks
Profile I		Blanc adonised	One size fits all	1 week
Profile J		Blanc adonised	One size fits all	1 week

* Profiles in Special / Custom colours are only available in combination with a ROCKPANEL board material order.

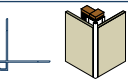
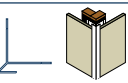
** When using board material with a panel thickness of 9 mm (FS-Xtra), a 10 mm profile is required.

ROCKPANEL Profiles Lines²

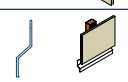
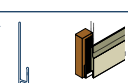
Standard length is 3055 mm	Colour*	Panel thickness	Availability
Profile C 	Blanc adonised 20 Standard/ 4 Bright Special/ Custom	10 mm	1 week 4 weeks 6 weeks
Profile D 	Blanc adonised 20 Standard/ 4 Bright Special/ Custom	10, 12 mm**	1 week 4 weeks 6 weeks
Profile E 	Blanc adonised 20 Standard/ 4 Bright Special/ Custom	10 mm	1 week 4 weeks 6 weeks
Profile F 	Blanc adonised 20 Standard/ 4 Bright Special/ Custom	10 mm	1 week 4 weeks 6 weeks
Profile H 	Blanc adonised 20 Standard/ 4 Bright Special/ Custom	10 mm	1 week 4 weeks 6 weeks
Profile I 	Blanc adonised	One size fits all	1 week
Profile J 	Blanc adonised	10 mm	1 week
Profile K*** 	Blanc adonised	One size fits all	1 week

* Profiles in Special / Custom colours are only available in combination with a ROCKPANEL board material order.

** When using Lines² 8 mm with a ROCKPANEL clip, a 12 mm profile is required.

*** For easy connection at ground level, a ROCKPANEL starting profile (type K) can be used for placement of the lowest section of ROCKPANEL Lines².

Fixing method

	Colour*	Indicative usage per m ² **	Availability
Ring shank nails 27 mm	Blanc	10 pieces	A stock item
Ring shank nails 32 mm	Blanc 20 standard / 4 Bright	12 pieces	A stock item A stock item
Screws 35 mm	Blanc 20 standard / 4 Bright	8 pieces	A stock item

Adhesive method

	Quantity	Indicative usage per 100 m ² **	Availability
ROCKPANEL Tack-S *** (ETA certified)	290 ml	50 cartridges	A stock item
Primer MSP Transparent (Back of board)	500 ml	6 cans	A stock item
Prep M (Aluminium frames)	500 ml	2 cans	A stock item
Foam tape (double sided)	25 m	12 rolls	A stock item
Cleaner Liquid 1	1 litre	1 can	A stock item

Other accessories

	Quantity	Availability
EPDM Foam tape (adhesive) 36 mm	50 m	A stock item
EPDM Foam tape (adhesive) 60 mm	50 m	A stock item
EPDM Foam tape (adhesive) 80 mm	50 m	A stock item
EPDM Foam tape (adhesive) 100 mm	25 m	A stock item
ROCKPANEL graffiti cleaner	780 ml	A stock item
ROCKPANEL edge paint	750 ml	A stock item

* Fixings in Special / Custom colours have a delivery time of maximum 6 weeks.

** With 32 mm nails and 35 mm screws assuming a panel thickness of 8 mm, with 27 mm nails assuming Lines² 10 mm. Actual consumption will depend on panel size, connections and height of the building. The example assumes a maximum panel size and span.

*** Adhesive installation of ROCKPANEL board material should be carried out according to the instructions of the supplier of the adhesive system and under his supervision and warranty conditions. If you choose to work with an adhesive system that is thoroughly tested with ROCKPANEL board material, you can work with the Tack-S adhesive system (ETA certified). Contact the ROCKPANEL Group for more information and your nearest supplier.

PRODUCT PROPERTIES

Property	Value	Unit	Standard
Mechanical			
Modulus of elasticity	4015 (Durable) 5260 (Xtreme) 4740 (FS-Xtra)	N/mm ²	EN 310 / EN 1058
Characteristic bending strength (f_{05})	≥ 27 (Durable) ≥ 34.5 (Xtreme) ≥ 25.5 (FS-Xtra)	N/mm ²	EN 310 / EN 1058
Optical			
Colour authenticity (5.000 hours; Xenon test)	Rockclad / Lines ² : 3-4 and better Rockclad (PP) / Metallics / Brilliant / Woods / Chameleon: 4 and better	Greyscale	EN 20105-A02
Fire			
Fire classification	Euroclass B-s2,d0 (Durable/Xtreme)* NEW A2-s1,d0 (FS-Xtra)		EN 13501-1
Physical			
Nominal mass of surface	6 mm: 6,3 (Durable) 8 mm: 8,4 (Durable)	kg/m ²	
Vapour permeable S_d (at 23°C and 85% RH)	ROCKPANEL Rockclad: < 1,8 Boards with ProtectPlus finish: < 3,5 **	m	EN-ISO 12572:2001
Dimensional stability			
Dimensional stability arising from changes in temperature	11 · 10 ⁻³ (Durable) 13 · 10 ⁻³ (Xtreme)	mm/m·K	EN 438-2
Expansion due to moisture between conditions of 23°C/50% RH and 23°C/95% RH	0,302 (Durable) ≤ 0.209 (Xtreme)	mm/m (after 4 days)	

For properties/more properties of the other grades see www.rockpanel.co.uk.

* Depending on the colour and bearing constructions in some cases a sub classification of s1 can be achieved (see ETA-13/0340).

** With the exception of ROCKPANEL Metallics Aluminium White and Aluminium Grey and all Brilliant and Chameleon boards, s_d value > 3,5. Lines² is vapour closed.

CERTIFICATES AND APPROVALS

ETA and CE marking

With regard to the EOTA procedure for innovative products, ROCKPANEL boards have been evaluated and approved in accordance with the European Assessment Document (EAD) no. 090001-00-0404. On the basis of this approval ROCKPANEL products have received a European Technical Assessment (ETA). With regard to the ETA all products have a declaration of performance and CE marking thereby fully complying with the construction product regulations in the UK and Europe.

ETA

- ETA-07/0141: "ROCKPANEL Durable Colours 8 mm and ROCKPANEL Durable 8 mm finish ProtectPlus".
- ETA-08/0343: "ROCKPANEL Durable 6 mm finish Colours/Rockclad".
- ETA-12/0054: "ROCKPANEL Xtreme 8 mm finish Colours/Rockclad and ROCKPANEL Xtreme 8 mm finish ProtectPlus".
- ETA-13/0340: "ROCKPANEL FS-Xtra 9 mm finish Colours/Rockclad and ROCKPANEL FS-Xtra 9 mm finish ProtectPlus".
- ETA-03/0204: "ROCKPANEL Lines², 8 mm and 10 mm tongue and groove panels finish Colours/Rockclad".
- ETA-13/0019: "ROCKPANEL PLY 6 mm, 8 mm and 10 mm".
- ETA-13/0648: "ROCKPANEL Natural Durable 8 mm and 10 mm / ROCKPANEL Natural Xtreme 8 mm and 10 mm".

MORE INFORMATION

Sample requests

By using the contact form on www.rockpanel.co.uk/contact you can easily request a sample.

ROCKPANEL boards; It is possible!

If you would like to receive an e-mail with advice on how to use ROCKPANEL boards, that's possible too! Register your e-mail address at www.rockpanel.co.uk.

Great attention to the accuracy of this document was taken during its compilation. The ROCKPANEL Group cannot, however, guarantee the total accuracy of the information included. Note also that the diagrams, colours, descriptions and statements relating to dimensions, characteristics, and so on are approximate and are not legally binding. All the information in this document is protected by copyright. This document, the text, photographs, other information and/or sections of this document cannot be reproduced, modified or published without prior written consent from the ROCKPANEL Group.

NOTES

The ROCKPANEL® Group is part of ROCKWOOL International®.

The ROCKPANEL Group manufactures board material for exterior cladding from the sustainable resource, basalt rock. Trends like stratification, organic forms and sustainability, in combination with a strong emphasis on costs and installation time, demand a flexible but robust board material to meet every desired format and shape.

The advantages of stone and wood are brought together in one product with ROCKPANEL boards. ROCKPANEL board material has been used for many years in numerous countries across the world for the finishing of facades, roofline applications and building details. The product is very often used as decorative cladding in ventilated structures, where the boards contribute to a cost-efficient and aesthetically high-quality outer shell for both renovation and new construction projects.

